



PRODUCT CATALOG

PAGE 01-06

PAGE 07-08

PAGE 09-22

PAGE 23-30

PAGE 31-48

PAGE 49-56

PAGE 57-62

PAGE 63-70

PAGE 70-74

PAGE 75-78

DXZ

LED Light Bar

Off-Road Lights

LED Driving Lights

LED Work Light

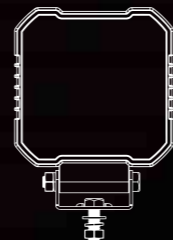
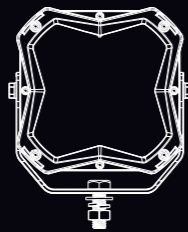
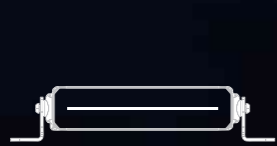

LED Motorcycle lights

FORKLIFT LAMP

LED Warning Light

RGB Decoration Light

Auto Accessories

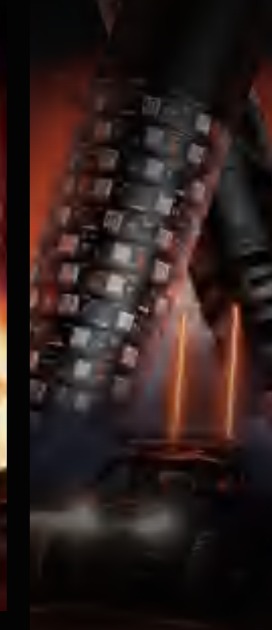
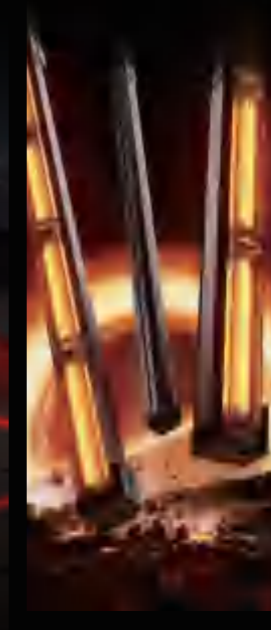
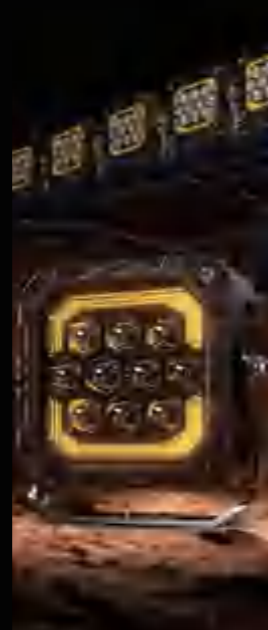
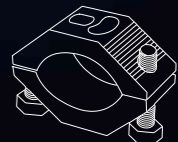
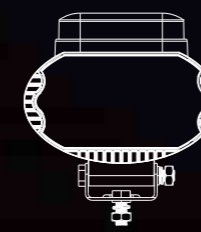

COMPANY PROFILE



Production Experience



Professional Equipment

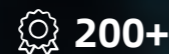

Professional Certificate

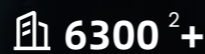

Factory Area

GUANGDONG DXZ LIGHTING TECHNOLOGY CO., LTD.

Founded in 2014, located in Foshan, China. It has a 6,000 m² workshop, 12 production lines, 100+ employees, and 10+ engineers/technicians.

Integrates R&D, manufacturing, and sales of high-quality automotive lighting products, including LED driving lights, work lights, light bars, motorcycle spotlights, warning lights, headlights, etc., for cars, trucks, and motorcycles.

Adheres to innovation, quality, and service, and has won customers' recognition with high-quality and cost-effective products.

Welcomes global partners to visit for guidance, communication, and cooperation. It is committed to providing high-quality products and considerate services to achieve win-win results.

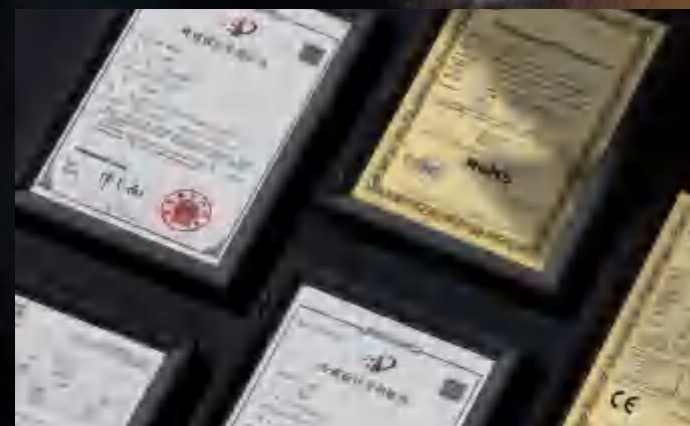

AUTHORITATIVE CERTIFICATION QUALITY GUARANTEE

AUTHORITATIVE CERTIFICATION QUALITY GUARANTEE

We concentrate on designing and making new high-quality automotive LED lights, with over 200 product patents to our name.

The company has passed IATF16949, ISO9001 quality certification system and CE, ROHS, FCC, E-MARK and other international qualification certification.

OUR SERVICE ADVANTAGES



Extensive experience in production

After more than a decade of dedication to production and manufacturing, we have built a full-process control system from raw materials to finished products, and laid a solid foundation for the quality of every product with our mature experience.



Professional team

All core members of our team have over 10 years of experience in automotive lamps, with expertise in optical design and vehicle-grade testing. From adjusting lighting performance to conducting 18 items of vehicle-grade testing, we ensure every work light is stable and reliable.



Source manufacturer

Advanced equipment, a strong professional team, and a source factory with comprehensive equipment and sophisticated processes



Customer-first, full-chain response to needs

In the early stage, we customize exclusive solutions and provide sample testing; during production, we synchronize progress updates and make flexible optimizations; after-sales, we offer 24-hour response and technical support—all to ensure customers receive products that are well-adapted and reliable.



SPECIALIZE IN AUTOMOTIVE

OEM & ODM ACCEPTED

We can meet the diverse needs of customers, with fully equipped facilities and leading quality.

Our service is seeking to meet the customer wishes for all lighting design needs, any opportunity to explore the adventures for lighting development is valuable for us.

ONE-STOP SERVICE

Pre-production: Customized solutions & sample testing.
In-production: Real-time progress synchronization & flexible optimization.
After-sales: 24-hour response & technical support.
All to ensure product adaptability and reliability for customers.

TERRA DXZ BRAND



PART NO. 3C04

Parameter

Voltage	Power	LED Chios	Lm	Lx
9-30VDC	16.9W/12V@1.4A	3535*2	1004LM	1lx@224.5m

Material: Aluminum
 Color: White+Amber
 Beam pattern: Spot+DRL
 Cable: 138m
 Waterproof rating: IP68/IP69K
 Dperating temperature: -40° C-85° C
 certificate: ROHS.CE.
 Packing: 5Set/CTN(62×32×22cm)

Spectral graph

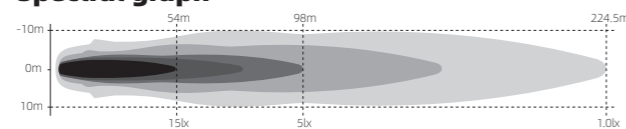

Dimensions

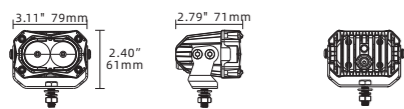

PART NO. 3C05

Parameter

Voltage	Power	LED Chios	Lm	Lx
9-30VDC	16.9W/12V@1.4A	3535*2	1004LM	1lux@71m

Material: Aluminum
 Color: White+Amber
 Beam pattern: Flood+DRL
 Cable: 3m
 Waterproof rating: IP68/IP69K
 Dperating temperature: -40° C-85° C
 certificate: ROHS.CE.
 Packing: 5Set/CTN(62×32×22cm)

Spectral graph

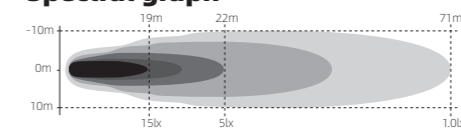

Dimensions

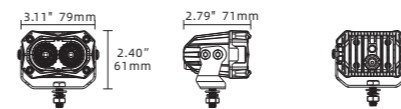

PART NO. 3C02

Parameter

Voltage	Power	LED Chios	Lm	Lx
9-30VDC	20W/12V@1.7A	3570*4pcs	870LM	1lx@165m

Material: Aluminum
 Color: White+Amber
 Beam pattern: Spot+DRL
 Cable: 3m
 Waterproof rating: IP68/IP69K
 Dperating temperature: -40° C-85° C
 certificate: ROHS.CE.
 Packing: 55Set/CTN(62×32×22cm)

Spectral graph

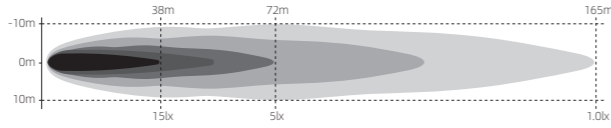

Dimensions

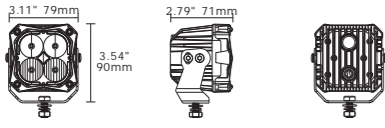

PART NO. 5C01

Parameter

Voltage	Power	LED Chios	Lm	Lux
9-30VDC	37W/12V@3.07A	p9+3030*4	2551LM	1lux@422m

Material: Aluminum
 Color: White+Amber
 Beam pattern: Spot+DRL
 Cable: 3m
 Waterproof rating: IP68/IP69K
 Dperating temperature: -40° C-85° C
 certificate: ROHS.CE.
 Packing: 55Set/CTN(65×31×31cm)

Spectral graph

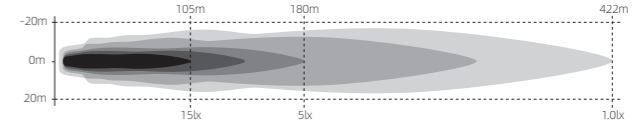

Dimensions

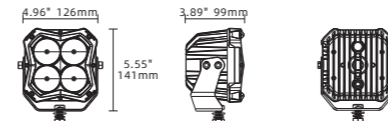

PART NO. 8C01

Parameter

Voltage	Power	LED Chios	Lm	Lux
9-30VDC	159W/12V@13A	5050*16*4pcs	8738LM	1lux@610m

Material: Aluminum
 Color: White+Amber
 Beam pattern: Spot+DRL
 Cable: 3m
 Waterproof rating: IP68/IP69K
 Dperating temperature: -40° C-85° C
 certificate: ROHS.CE.
 Packing: 35Set/CTN(63×32×49cm)

Spectral graph

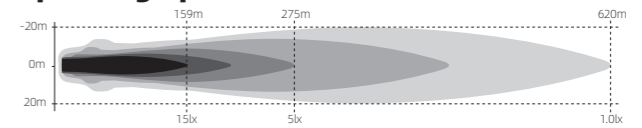

Dimensions

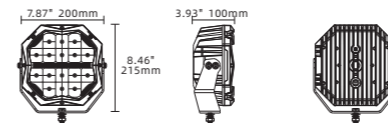

PART NO. 45C01

Parameter

Voltage	Power	LED Chios	Lm	Lux
9-30VDC	48W/12V@3.87A	5050*3pcs	LM2881	1lux@295m

Material: Aluminum
 Color: White+Amber
 Beam pattern: Spot+DRL
 Cable: 3m
 Waterproof rating: IP68/IP69K
 Dperating temperature: -40° C-85° C
 certificate: ROHS.CE.
 Packing: 55Set/CTN(57.5×28×27.5cm)

Spectral graph

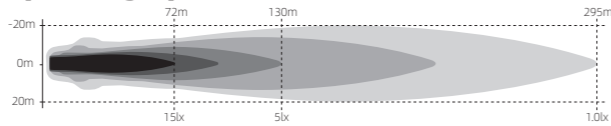

Dimensions

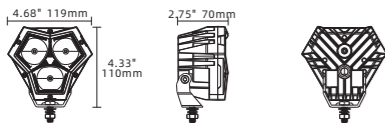

PART NO. 20C02

Spectral graph

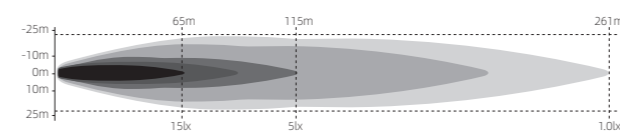

Dimensions

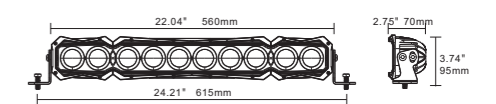

Parameter

Voltage	Power	LED Chios	lLm(Theoretical)	Lux	Color
9-30VDC	164W/12V@12.55A	5050*10	3339LM	1lux@261m	White+Amber+RGB

Material: Aluminum
 Beam pattern: Stop
 Cable: 3m
 Waterproof rating: IP68/IP69K
 Dperating temperature: -40° C-85° C
 certificate: ROHS.CE.
 Packing: 4Set/CTN(85.5×27.5×26.5cm)



PART NO. 45C04

Parameter

Voltage	Power	LED Chios	Lm	Lux
9-30VDC	58W/12V/@4.8A	5050+3030*2+22pcs	3047LM	1lux@298m

Material: Aluminum
 Color: White+Amber
 Beam pattern: Spot+DRL
 Cable: 3m
 Waterproof rating: IP68/IP69K
 Dperating temperature: -40° C-85° C
 certificate: ROHS.CE.
 Packing: 55Set/CTN(70.5×32.5×27cm)

Spectral graph

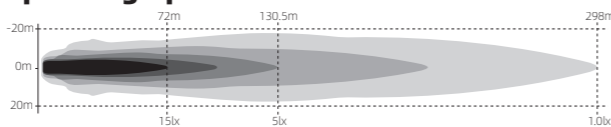

Dimensions

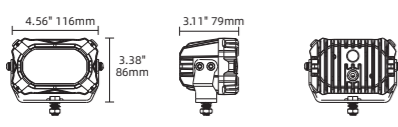

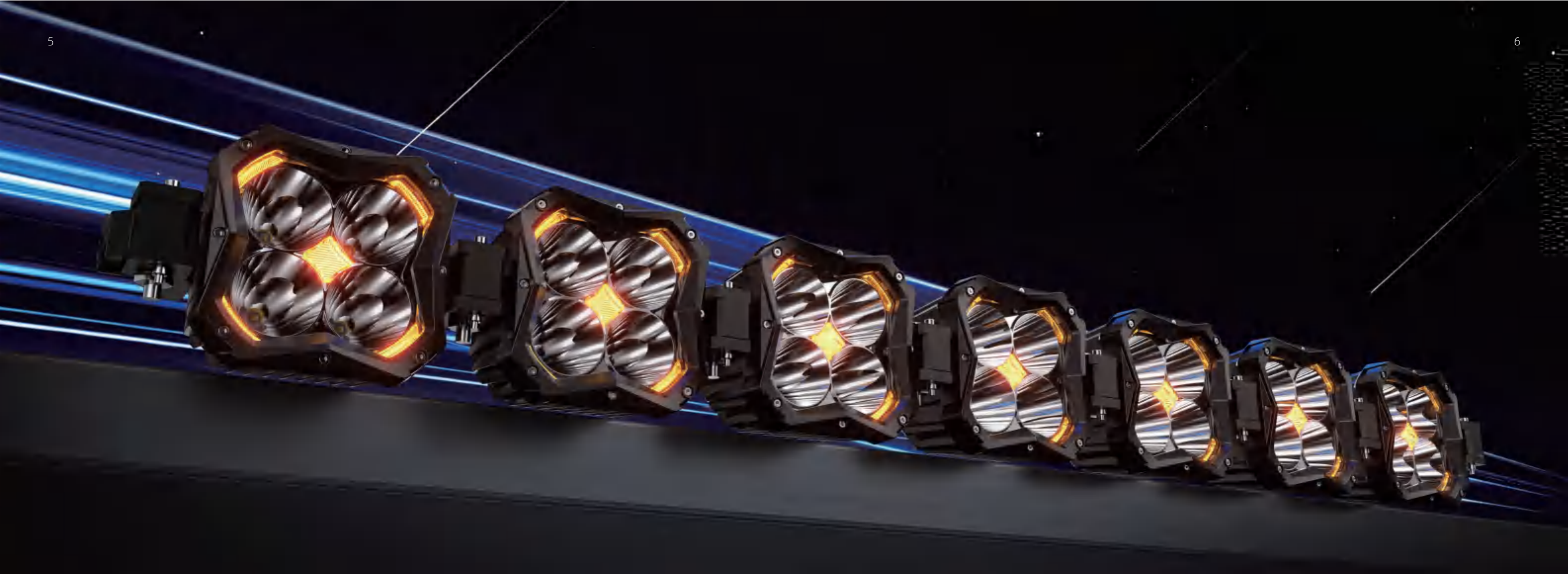

TAKE US ON YOUR NEXT ADVENTURE

DXZ

Real adventures don't pause for darkness. This LED light bar cuts through the void with ultra-high lumen output, while its precision-engineered reflectors project a focused beam to expose every turn and obstacle ahead—whether on rocky trails, desert dunes, or forest paths.

Built with aircraft-grade aluminum and IP68 waterproof/dustproof rating, it withstands the harshest elements, from sandstorms to heavy rain. It's more than just a light; it's your confidence to conquer the unknown. Switch it on, and the path unfolds.



PART NO. LP-5C01-3/4/5/6/7/8P

Dimensions	3LED:510-515mm	
	4LED:667-674mm	
	5LED:826-834mm	
	6LED:984-994mm	
	7LED:1142-1155mm	
	8LED:1299-1313mm	

Parameter

Voltage	Power	LED Chios	Lm(Theoretical)	Lux	Color
9-30VDC	120/160/200/240/280/320W	p9+3030*12/16/20/16/20/24/28/32	30000/40000/50000/60000/70000/80000LM	1lux@1000m	White+Amber

Material: Aluminum
 Beam pattern: Stop+DRL
 Cable: 3m
 Waterproof rating: IP68/IP69K
 Operating temperature: -40° C-85° C
 certificate: ROHS,CE.

LED LIGHT BAR

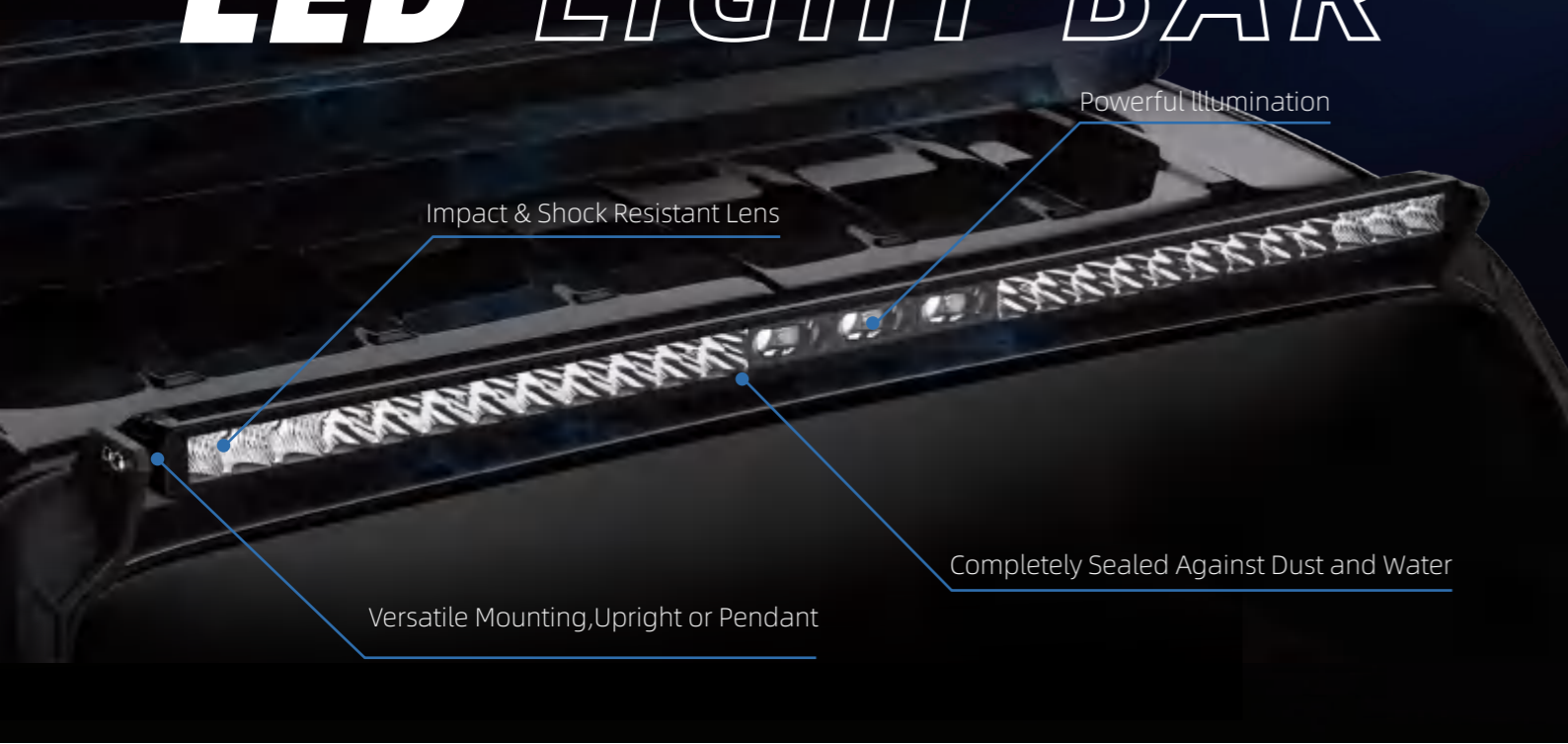

Impact & Shock Resistant Lens

Powerful Illumination

Completely Sealed Against Dust and Water

Versatile Mounting,Upright or Pendant

TAKE US ON YOUR NEXT ADVENTURE

Crafted for durability, they boast an IP65 dustproof and waterproof rating. Their protective capabilities make them ideal for all harsh environments. No matter where your adventure takes you.

Choose from various sizes and power outputs up to 26,000 lumens to find the perfect fit for your off-road needs. Light up your path with LED light bars and explore the night like never before.



PART NO. RS1TJ

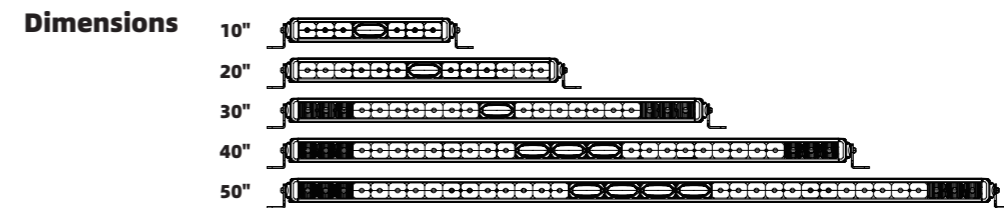

Parameter

Voltage	Power	LED Chios	ILm(Theoretical)	Color
9-30VDC	20/30/45/65/83W	2525	4000/6000/9000/13000/16600LM	White

Material: Aluminum
 Beam pattern: Stop
 Cable: 45cm
 Waterproof rating: IP68/IP69K
 Dperating temperature: -40° C-85° C
 certificate: ROHS.CE.



PART NO. RL2C

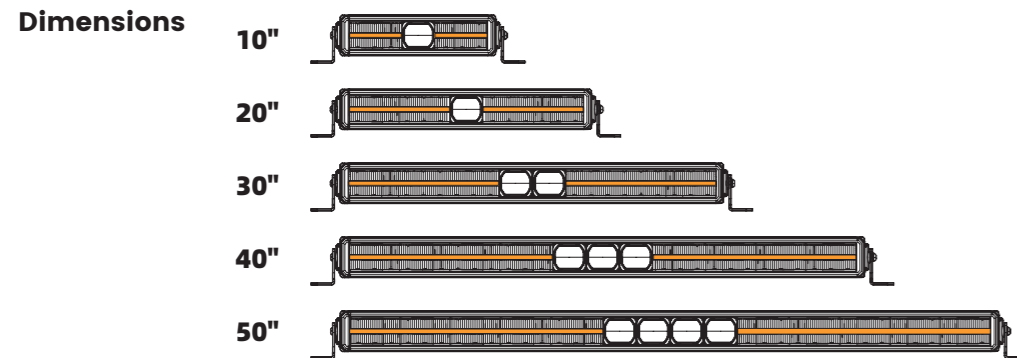

Parameter

Voltage	Power	LED Chios	ILm(Theoretical)	Color
9-30VDC	30/45/70/100/130W	2525	6000/9000/14000/20000/26000LM	White+Amber

Material: Aluminum
 Beam pattern: Stop+DRL
 Cable: 45cm
 Waterproof rating: IP68/IP69K
 Dperating temperature: -40° C-85° C
 certificate: ROHS.CE.



PART NO. RL1C

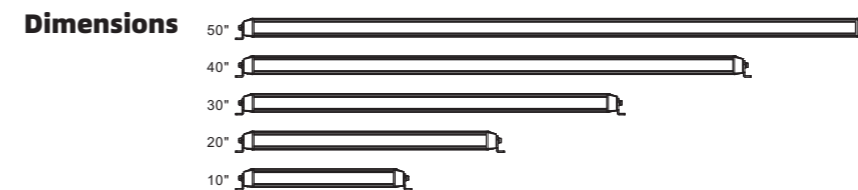

Parameter

Voltage	Power	LED Chios	ILm(Theoretical)	Color
9-30VDC	35/70/110/147/175W	3030	6000/9000/14000/20000/26000LM	White

Material: Aluminum
 Beam pattern: Stop
 Cable: 45cm
 Waterproof rating: IP68/IP69K
 Dperating temperature: -40° C-85° C
 certificate: ROHS.CE.



OFF-ROAD LIGHTS



Dimensions

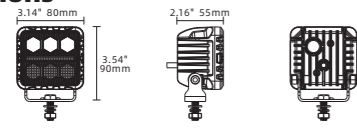

PART NO. BF3-A6

Parameter

Voltage	Power	LED Chios	Lm	Lux
9-32VDC	17.8W/12V@1.48A	3030*6+6	2400LM	1lux@240m

Material: Aluminum
 Color: White+Yellow
 Beam pattern: Spot+Flood
 Cable: 3m
 Waterproof rating: IP68/IP69K
 Dperating temperature: -40° C-85° C
 certificate: ROHS.CE.
 Packing: 3Set/CTN(63×32×49cm)



Dimensions

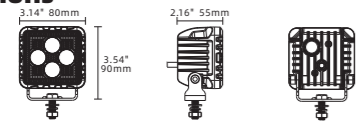

PART NO. BF3-A4X

Parameter

Voltage	Power	LED Chios	Lm	Lux
9-32VDC	18W/12V@1.5A	3030*4+12	3200LM	1lux@300m

Material: Aluminum
 Color: White+Yellow
 Beam pattern: Spot+Flood
 Cable: 3m
 Waterproof rating: IP68/IP69K
 Dperating temperature: -40° C-85° C
 certificate: ROHS.CE.
 Packing: 3Set/CTN(63×32×49cm)



Dimensions

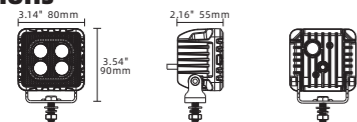

PART NO. BF3-A4

Parameter

Voltage	Power	LED Chios	Lm	Lux
9-32VDC	18.5W/12V@1.5A	3030*4+18	4400LM	1lux@265m

Material: Aluminum
 Color: White+Yellow
 Beam pattern: Spot+Flood
 Cable: 3m
 Waterproof rating: IP68/IP69K
 Dperating temperature: -40° C-85° C
 certificate: ROHS.CE.
 Packing: 3Set/CTN(63×32×49cm)



Dimensions

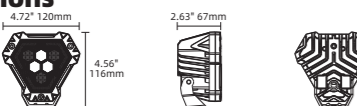

PART NO. BF45-6

Parameter

Voltage	Power	LED Chios	Lm	Lux
9-30VDC	87W/12V@7.2A(1pcs)	3535(10W)+3030*6+24pcs	11400LM	1lux@189.5m

Material: Aluminum
 Color: White+Amber
 Beam pattern: Spot+DRL
 Cable: 3m
 Waterproof rating: IP68/IP69K
 Dperating temperature: -40° C-85° C
 certificate: ROHS.CE.
 Packing: 5Set/CTN(46.5×34×27.5cm)



Dimensions

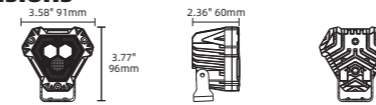

PART NO. BF35-3

Parameter

Voltage	Power	LED Chios	Lm	Lux
9-30VDC	60W/12V@5A(1pcs)	3535(10W)+3030*3+18pcs	6300LM	1lux@150m

Material: Aluminum
 Color: White+Yellow
 Beam pattern: Spot+DRL
 Cable: 3m
 Waterproof rating: IP68/IP69K
 Dperating temperature: -40° C-85° C
 certificate: ROHS.CE.
 Packing: 10Set/CTN(47×47×26cm)



Dimensions

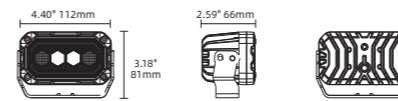

PART NO. BF45-4

Parameter

Voltage	Power	LED Chios	Lm	Lux
9-30VDC	70W/12V@5.8A(1pcs)	3535(10W)+3030*4+24pcs	8400LM	1lux@154m

Material: Aluminum
 Color: White+Yellow
 Beam pattern: Spot+DRL
 Cable: 3m
 Waterproof rating: IP68/IP69K
 Dperating temperature: -40° C-85° C
 certificate: ROHS.CE.
 Packing: 5Set/CTN(57.5×28×27cm)



Dimensions

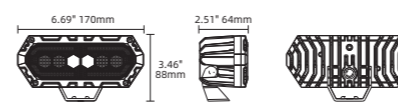

PART NO. BF5-6

Parameter

Voltage	Power	LED Chios	Lm	Lux
9-30VDC	31W/12V@2.6A	3535(10W)+3030*6+28pcs	8800LM	1lux@//m

Material: Aluminum
 Color: White+Yellow
 Beam pattern: Spot+DRL
 Cable: 80m
 Waterproof rating: IP68/IP69K
 Dperating temperature: -40° C-85° C
 certificate: ROHS.CE.
 Packing: //



Dimensions

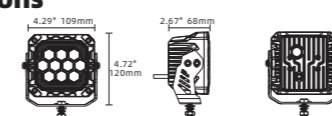

PART NO. PF4-10

Parameter

Voltage	Power	LED Chios	Lm	Lux
9-32VDC	38.3W/12V@3.18A	3030*10+24	2600LM	1lux@529m

Material: Aluminum
 Color: White+Amber
 Beam pattern: Spot
 Cable: 3m
 Waterproof rating: IP68/IP69K
 Dperating temperature: -40° C-85° C
 certificate: ROHS.CE.
 Packing: 3Set/CTN(63×32×49cm)



PART NO. PF4-14

Parameter

Voltage	Power	LED Chios	Lm	Lux
9-32VDC	120W/12V@19.9A	5050*12	2600LM	1lux@664m

Material: Aluminum
 Color: White+Yellow
 Beam pattern: Spot
 Cable: 3m
 Waterproof rating: IP68/IP69K
 Dperating temperature: -40° C-85° C
 certificate: ROHS.CE.
 Packing: 3Set/CTN(63×32×49cm)

Dimensions

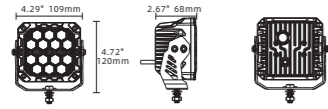

PART NO. PF4-9

Parameter

Voltage	Power	LED Chios	Lm	Lux
9-32VDC	120W/12V@19.9A	5050*12	2600LM	1lux@555m

Material: Aluminum
 Color: White+Yellow
 Beam pattern: Spot
 Cable: 3m
 Waterproof rating: IP68/IP69K
 Dperating temperature: -40° C-85° C
 certificate: ROHS.CE.
 Packing: 3Set/CTN(63×32×49cm)

Dimensions

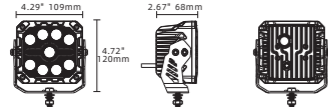

PART NO. BF3-B6

Parameter

Voltage	Power	LED Chios	Lm	Lux
9-32VDC	17.8W/12V@1.47A	3030*6+6	2400LM	1lux@529m

Material: Aluminum
 Color: White+Yellow
 Beam pattern: Spot+Flood
 Cable: 3m
 Waterproof rating: IP68/IP69K
 Dperating temperature: -40° C-85° C
 certificate: ROHS.CE.
 Packing: 3Set/CTN(63×32×49cm)

Dimensions

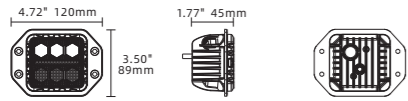

PART NO. BF3-B4X

Parameter

Voltage	Power	LED Chios	Lm	Lux
9-32VDC	18W/12V@1.5A	3030*4+12	2400LM	1lux@1100m

Material: Aluminum
 Color: White+Yellow
 Beam pattern: Spot+Flood
 Cable: 3m
 Waterproof rating: IP68/IP69K
 Dperating temperature: -40° C-85° C
 certificate: ROHS.CE.
 Packing: 3Set/CTN(63×32×49cm)

Dimensions

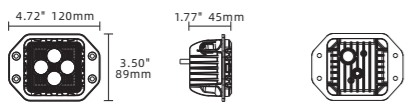

PART NO. BF3-B4

Parameter

Voltage	Power	LED Chios	Lm	Lux
9-32VDC	18.6W/12V@1.54A	3030*4+18	4400LM	1lux@276m

Material: Aluminum
 Color: White+Yellow
 Beam pattern: Spot+Flood
 Cable: 3m
 Waterproof rating: IP68/IP69K
 Dperating temperature: -40° C-85° C
 certificate: ROHS.CE.
 Packing: 3Set/CTN(63×32×49cm)

Dimensions

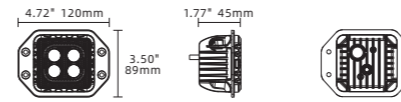

PART NO. BF6-1F-4

Parameter

Voltage	Power	LED Chios	Lm	Lux
9-32VDC	19.8W/12V@1.65A	3030*4	2600LM	1lux@84m

Material: Aluminum
 Color: White+Yellow
 Beam pattern: Spot+Flood
 Cable: 3m
 Waterproof rating: IP68/IP69K
 Dperating temperature: -40° C-85° C
 certificate: ROHS.CE.
 Packing: 3Set/CTN(63×32×49cm)

Dimensions

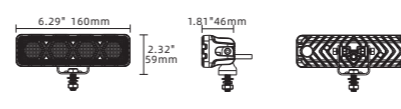

PART NO. BF6-1F-5

Parameter

Voltage	Power	LED Chios	Lm	Lux
9-32VDC	18W/12V@1.5A	3030*5	2600LM	1lux@288m

Material: Aluminum
 Color: White+Yellow
 Beam pattern: Spot+Flood
 Cable: 3m
 Waterproof rating: IP68/IP69K
 Dperating temperature: -40° C-85° C
 certificate: ROHS.CE.
 Packing: 3Set/CTN(63×32×49cm)

Dimensions

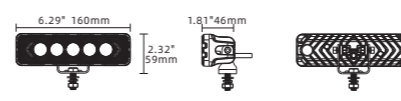

PART NO. BF6-1F-6

Parameter

Voltage	Power	LED Chios	Lm	Lux
9-32VDC	17.8W/12V@1.48A	3030*6	2600LM	1lux@240m

Material: Aluminum
 Color: White+Yellow
 Beam pattern: Spot+Flood
 Cable: 3m
 Waterproof rating: IP68/IP69K
 Dperating temperature: -40° C-85° C
 certificate: ROHS.CE.
 Packing: 3Set/CTN(63×32×49cm)

Dimensions

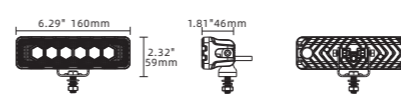



Dimensions

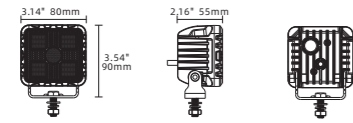

PART NO. BF3-A20

Parameter

Voltage	Power	LED Chios	Lm	Lux
9-32VDC	18.6W/12V@1.54A	3030*20	2000LM	1lux@57m

Material: Aluminum
 Color: White
 Beam pattern: Flood
 Cable: 3m
 Waterproof rating: IP68/IP69K
 Dperating temperature: -40° C-85° C
 certificate: ROHS.CE.
 Packing: 3Set/CTN(63×32×49cm)



Dimensions

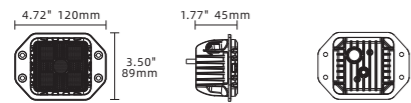

PART NO. BF3-B20

Parameter

Voltage	Power	LED Chios	Lm	Lux
9-32VDC	18.3W/12V@1.51A	3030*20	2000LM	1lux@59m

Material: Aluminum
 Color: White
 Beam pattern: Flood
 Cable: 3m
 Waterproof rating: IP68/IP69K
 Dperating temperature: -40° C-85° C
 certificate: ROHS.CE.
 Packing: 3Set/CTN(63×32×49cm)



Dimensions

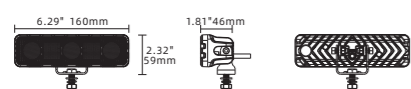

PART NO. BF6-1F-20

Parameter

Voltage	Power	LED Chios	Lm	Lux
9-32VDC	17.8W/12V@1.48A	3030*20	2000LM	1lux@85m

Material: Aluminum
 Color: White
 Beam pattern: Flood
 Cable: 3m
 Waterproof rating: IP68/IP69K
 Dperating temperature: -40° C-85° C
 certificate: ROHS.CE.
 Packing: 3Set/CTN(63×32×49cm)



Dimensions

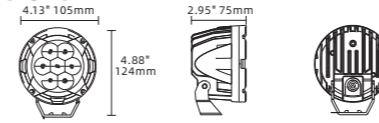

PART NO. PY4-7-Spot

Parameter

Voltage	Power	LED Chios	Lm	Lux
9-30VDC	120W/12V@19.9A	5050*12	4000LM	1lux@748m

Material: Aluminum
 Color: White+Yellow
 Beam pattern: Spot
 Cable: 3m
 Waterproof rating: IP68/IP69K
 Dperating temperature: -40° C-85° C
 certificate: ROHS.CE.
 Packing: 3Set/CTN(63×32×49cm)



Dimensions

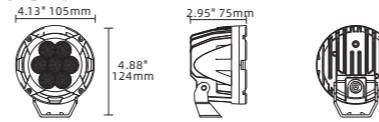

PART NO. PY4-7-Flood

Parameter

Voltage	Power	LED Chios	Lm	Lux
9-32VDC	120W/12V@19.9A	3535*7	4000LM	1lux@201m

Material: Aluminum
 Color: White+Yellow
 Beam pattern: Flood
 Cable: 3m
 Waterproof rating: IP68/IP69K
 Dperating temperature: -40° C-85° C
 certificate: ROHS.CE.
 Packing: 3Set/CTN(63×32×49cm)



Dimensions

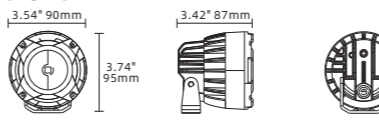

PART NO. PY35-1-Spot

Parameter

Voltage	Power	LED Chios	Lm	Lux
9-32VDC	120W/12V@19.9A	3535*7	4000LM	1lux@178m

Material: Aluminum
 Color: White+Yellow
 Beam pattern: Spot
 Cable: 3m
 Waterproof rating: IP68/IP69K
 Dperating temperature: -40° C-85° C
 certificate: ROHS.CE.
 Packing: 3Set/CTN(63×32×49cm)



Dimensions

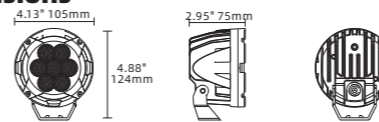

PART NO. PY35-1-Flood

Parameter

Voltage	Power	LED Chios	Lm	Lux
9-32VDC	120W/12V@19.9A	7070*1	4000LM	1lux@172m

Material: Aluminum
 Color: White+Yellow
 Beam pattern: Flood
 Cable: 3m
 Waterproof rating: IP68/IP69K
 Dperating temperature: -40° C-85° C
 certificate: ROHS.CE.
 Packing: 3Set/CTN(63×32×49cm)



PART NO. PF5-6

Parameter

Voltage	Power	LED Chios	Lm	Lux
9-32VDC	59W/12V@4.94A	5050*6	12000LM	1lux@603m

Material: Aluminum
 Color: White+White/Yellow (DRL)
 Beam pattern: Spot
 Cable: 3m
 Waterproof rating: IP68/IP69K
 Dperating temperature: -40° C-85° C
 certificate: ROHS.CE.
 Packing: 5Set/CTN(70.5x32.5x27cm)

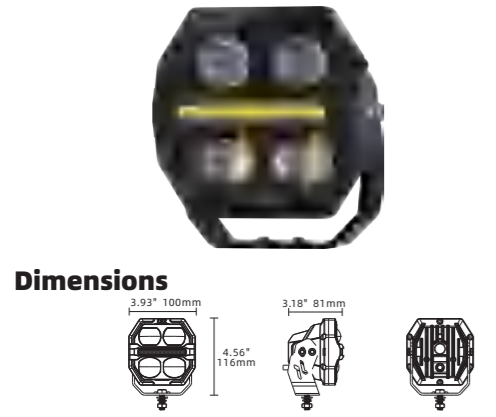

PART NO. PF4-4

Parameter

Voltage	Power	LED Chios	Lm	Lux
9-32VDC	64W/12V@5.4A	3570*4	12000LM	1lux@587m

Material: Aluminum
 Color: White+White/Yellow (DRL)
 Beam pattern: Spot
 Cable: 3m
 Waterproof rating: IP68/IP69K
 Dperating temperature: -40° C-85° C
 certificate: ROHS.CE.
 Packing: 5Set/CTN(70.5x32.5x27cm)

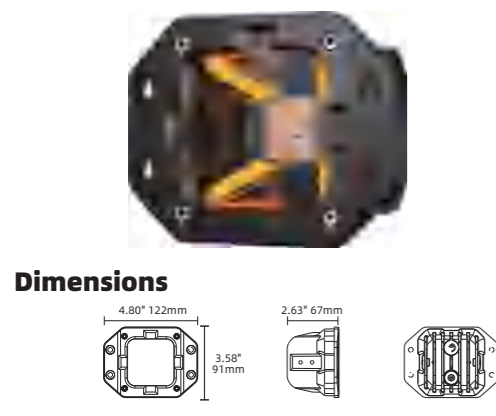

PART NO. BF3-B1

Parameter

Voltage	Power	LED Chios	Lm	Lux
9-32VDC	40W/12V@3.3A(1pcs)	5050+3030*1+4pcs	2000LM	1lux@//m

Material: Aluminum
 Color: White+Yellow (DRL)
 Beam pattern: Spot
 Cable: 3m
 Waterproof rating: IP68/IP69K
 Dperating temperature: -40° C-85° C
 certificate: ROHS.CE.
 Packing: 10Set/CTN(57.5x28x27.5cm)



PART NO. BF3-A1

Parameter

Voltage	Power	LED Chios	Lm	Lux
9-32VDC	40W/12V@3.3A(1pcs)	5050+3030*1+4pcs	2000LM	1lux@//m

Material: Aluminum
 Color: White+Yellow (DRL)
 Beam pattern: Spot
 Cable: 3m
 Waterproof rating: IP68/IP69K
 Dperating temperature: -40° C-85° C
 certificate: ROHS.CE.
 Packing: 10Set/CTN(57.5x28x27.5cm)



PART NO. BY3-4

Parameter

Voltage	Power	LED Chios	Lm	Lux
9-30VDC	100W/12V@8.37A	3535(10W)+3030*4+26pcs	8600LM	1lux@//m

Material: Aluminum
 Color: White+Yellow
 Beam pattern: Spot
 Cable: 3m
 Waterproof rating: IP68/IP69K
 Dperating temperature: -40° C-85° C
 certificate: ROHS.CE.
 Packing: 10Set/CTN(47x47x26cm)

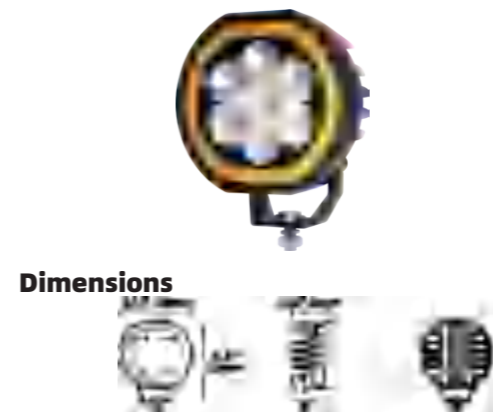

PART NO. BY45-7

Parameter

Voltage	Power	LED Chios	Lm	Lux
9-30VDC	121W/12V@10A	3535(10W)+3030*7+28pcs	13300LM	1lux@//m

Material: Aluminum
 Color: White+Yellow
 Beam pattern: Spot
 Cable: 3m
 Waterproof rating: IP68/IP69K
 Dperating temperature: -40° C-85° C
 certificate: ROHS.CE.
 Packing: 5Set/CTN(46.5x27.5x27.5cm)



PART NO. BF45-3

Parameter

Voltage	Power	LED Chios	Lm	Lux
9-30VDC	30W	3535(10W)+3030*3+22pcs	6700LM	1lux@//m

Material: Aluminum
 Color: White+Yellow
 Beam pattern: Spot
 Cable: //m
 Waterproof rating: IP68/IP69K
 Dperating temperature: -40° C-85° C
 certificate: ROHS.CE.
 Packing: 10Set/CTN(47x47x26cm)

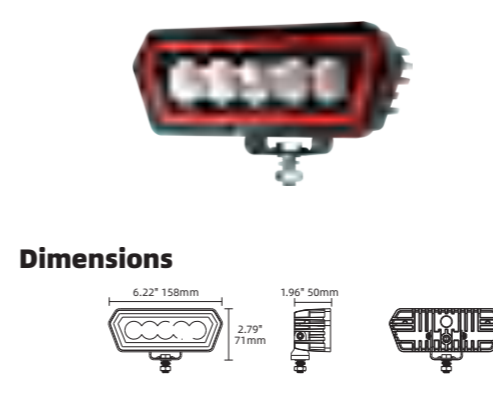

PART NO. PFD-6

Parameter

Voltage	Power	LED Chios	LM
9-32VDC	60W	3535 (10W) *6	9000LM

Material: Aluminum
 Color: White+Red
 Beam pattern: Spot
 Cable: //m
 Waterproof rating: IP68/IP69K
 Dperating temperature: -40° C-85° C
 certificate: ROHS.CE.



Dimensions

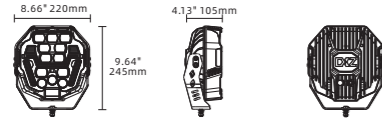

PART NO. PF9-12

Parameter

Voltage	Power	LED Chios	Lm	Lux
9-30VDC	112W/12V@9.9A	5050*12	24000LM	1lux@810m

Material: Aluminum
 Color: White+Amber
 Beam pattern: Spot+ Flood+DRL
 Cable: 3m
 Waterproof rating: IP68/IP69K
 Dperating temperature: -40° C-85° C
 certificate: ROHS.CE.
 Packing: 3Set/CTN(62x32x49cm)



Dimensions



PART NO. 3C01

Parameter

Voltage	Power	LED Chios	Lm	Lux
9-30VDC	30W/12V@2.5A	3570*3pcs	9000LM	1lux@298m

Material: Aluminum
 Color: White+Amber
 Beam pattern: Spot+DRL
 Cable: 3m
 Waterproof rating: IP68/IP69K
 Dperating temperature: -40° C-85° C
 certificate: ROHS.CE.
 Packing: 5Set/CTN(62x32x22cm)



Dimensions

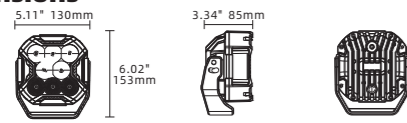

PART NO. PF5-12

Parameter

Voltage	Power	LED Chios	Lm	Lux
9-30VDC	84W/12V@6.4A	SST20*12	3840LM	1lux@818m

Material: Aluminum
 Color: White+White/Yellow (DRL)
 Beam pattern: Spot+ Flood+DRL
 Cable: 3m
 Waterproof rating: IP68/IP69K
 Dperating temperature: -40° C-85° C
 certificate: ROHS.CE.
 Packing: 5Set/CTN(64.5x46.5x22Ccm)



Dimensions

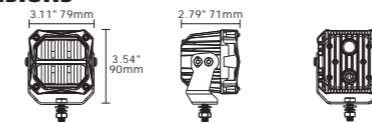

PART NO. 3C03

Parameter

Voltage	Power	LED Chios	Lm	Lux
9-30VDC	20W/12V@1.66A	3570*4pcs	12000LM	1lux@480m

Material: Aluminum
 Color: White+Amber
 Beam pattern: Flood+DRL
 Cable: 3m
 Waterproof rating: IP68/IP69K
 Dperating temperature: -40° C-85° C
 certificate: ROHS.CE.
 Packing: 5Set/CTN(62x32x22cm)



Dimensions

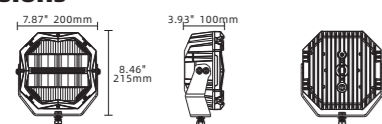

PART NO. 8C02

Parameter

Voltage	Power	LED Chios	Lm	Lux
9-30VDC	75W/12V@5.6A	5050*10*4pcs	8000LM	1lux@966m

Material: Aluminum
 Color: White+Amber
 Beam pattern: Flood+DRL
 Cable: 3m
 Waterproof rating: IP68/IP69K
 Dperating temperature: -40° C-85° C
 certificate: ROHS.CE.
 Packing: 3Set/CTN(62x32x49cm)



Dimensions

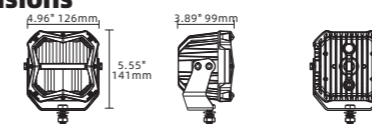

PART NO. 5C02

Parameter

Voltage	Power	LED Chios	Lm	Lux
9-30VDC	38.7W/12V@3.2A	p9+3030*4	10000LM	1lux@661m

Material: Aluminum
 Color: White+Amber
 Beam pattern: Spot+DRL
 Cable: 3m
 Waterproof rating: IP68/IP69K
 Dperating temperature: -40° C-85° C
 certificate: ROHS.CE.
 Packing: 5Set/CTN(65x31x31cm)

BETTER MATERIALS BRIGHT. DURABLE

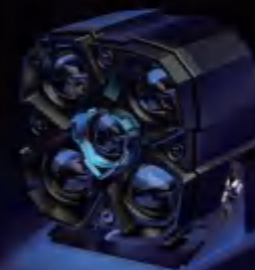

Dimensions



PART NO. 4C01

Parameter

Voltage	Power	LED Chios	Lm	Lux
9-30VDC	65W/12V@5.4A	3570+5050*5	12000LM	1lux@631m

Material: Aluminum
 Color: White+Amber
 Beam pattern: Flood+Spot
 Cable: 3m
 Waterproof rating: IP68/IP69K
 Dperating temperature: -40° C-85° C
 certificate: ROHS.CE.
 Packing: 5Set/CTN(53×34×26cm)

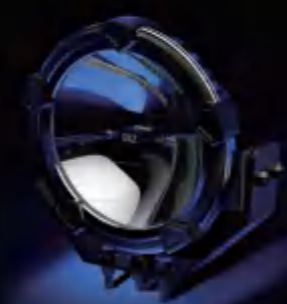

Dimensions



PART NO. ks60

Parameter

Voltage	Power	LED Chios	Lm	Lux
9-30VDC	30W	3570	6000LM	1lux@600m

Material: Aluminum
 Color: White
 Beam pattern: Spot
 Cable: 3m
 Waterproof rating: IP68/IP69K
 Dperating temperature: -40° C-85° C
 certificate: ROHS.CE.
 Packing: 2Set/CTN(43.5×33.5×26cm)



Dimensions

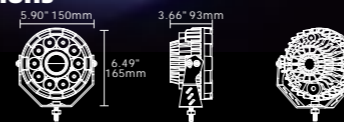

PART NO. 7C01

Parameter

Voltage	Power	LED Chios	Lm	Lux
9-30VDC	59W/12V@4.9A	p9+5050*11	12000LM	1lux@665m

Material: Aluminum
 Color: White+Amber
 Beam pattern: Spot
 Cable: 3m
 Waterproof rating: IP68/IP69K
 Dperating temperature: -40° C-85° C
 certificate: ROHS.CE.
 Packing: 5Set/CTN(64×45×24cm)

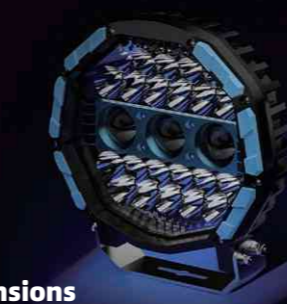

Dimensions



PART NO. 9C01

Parameter

Voltage	Power	LED Chios	Lm	Lux
9-30VDC	108W/12V@9A	p9+5050*25	18000LM	1lux@905m

Material: Aluminum
 Color: White+Amber
 Beam pattern: Spot
 Cable: 3m
 Waterproof rating: IP68/IP69K
 Dperating temperature: -40° C-85° C
 certificate: ROHS.CE.
 Packing: 3Set/CTN(64×28×38cm)



***BLAST THROUGH DARKNESS
DRIVE WORRY-FREE***

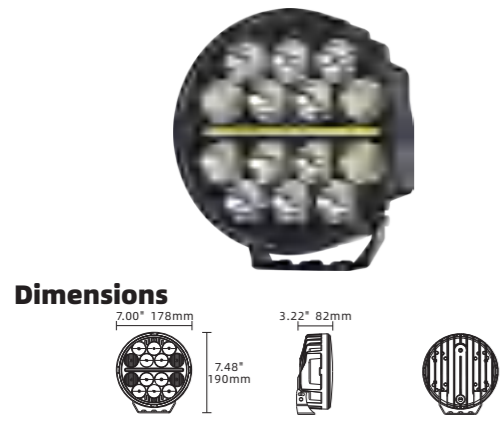

PART NO. 7R01

Parameter

Voltage	Power	LED Chios	Lm	Lux
9-36VDC	61W/12V@5.1A	3535*14pcs	14000LM	1lux@1109m

Material: Aluminum
 Color: White+Amber
 Beam pattern: Spot+DRL
 Cable: 60cm
 Waterproof rating: IP68/IP69K
 Dperating temperature: -40° C-85° C
 certificate: ROHS.CE.
 Packing: 5Pcs/CTN(57×29×25cm)

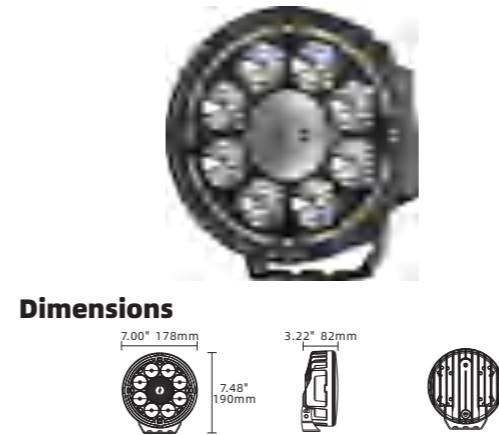

PART NO. 7R04

Parameter

Voltage	Power	LED Chios	Lm	Lux
9-36VDC	56.6W/12V@4.7A	3535*9pcs	13500LM	1lux@823m

Material: Aluminum
 Color: White+Amber
 Beam pattern: Spot+DRL
 Cable: 60cm
 Waterproof rating: IP68/IP69K
 Dperating temperature: -40° C-85° C
 certificate: ROHS.CE.
 Packing: 5Pcs/CTN(57×29×25cm)

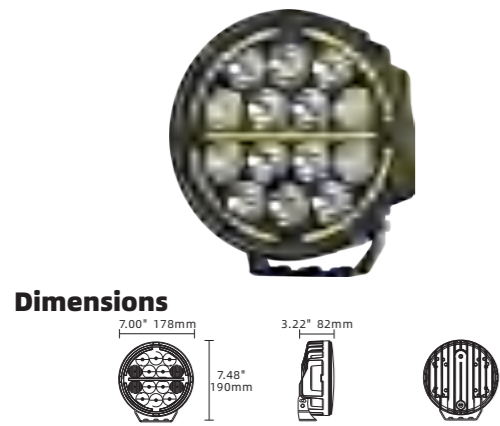

PART NO. 7R02

Parameter

Voltage	Power	LED Chios	Lm	Lux
9-36VDC	51W/12V@4.2A	3535*14pcs	14000LM	1lux@1062m

Material: Aluminum
 Color: White+Amber
 Beam pattern: Spot+DRL
 Cable: 60cm
 Waterproof rating: IP68/IP69K
 Dperating temperature: -40° C-85° C
 certificate: ROHS.CE.
 Packing: 5Pcs/CTN(57×29×25cm)

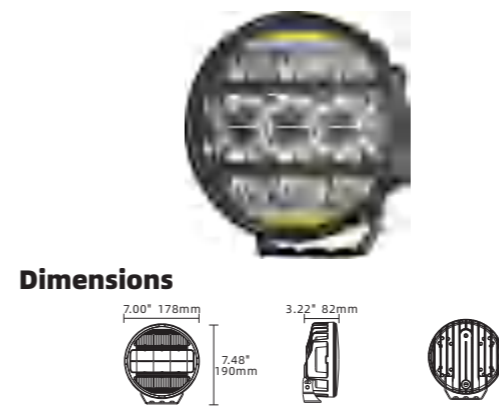

PART NO. 7R05

Parameter

Voltage	Power	LED Chios	Lm	Lux
9-36VDC	51W/12V@4.2A	3535*12pcs	12000LM	1lux@999m

Material: Aluminum
 Color: White+Amber
 Beam pattern: Spot+DRL
 Cable: 60cm
 Waterproof rating: IP68/IP69K
 Dperating temperature: -40° C-85° C
 certificate: ROHS.CE.
 Packing: 5Pcs/CTN(57×29×25cm)

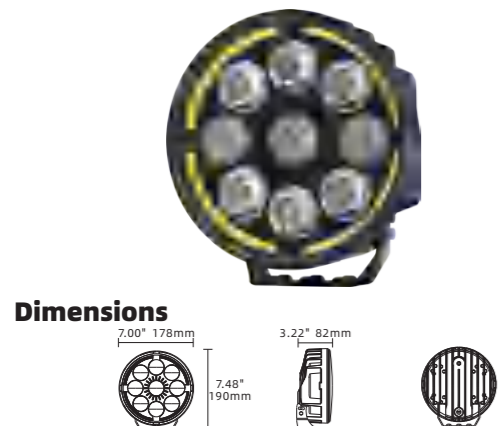

PART NO. 7R03

Parameter

Voltage	Power	LED Chios	Lm	Lux
9-36VDC	55W/12V@4.55A	3535*9pcs	13500LM	1lux@493m

Material: Aluminum
 Color: White+Amber
 Beam pattern: Spot+DRL
 Cable: 60cm
 Waterproof rating: IP68/IP69K
 Dperating temperature: -40° C-85° C
 certificate: ROHS.CE.
 Packing: 5Pcs/CTN(57×29×25cm)

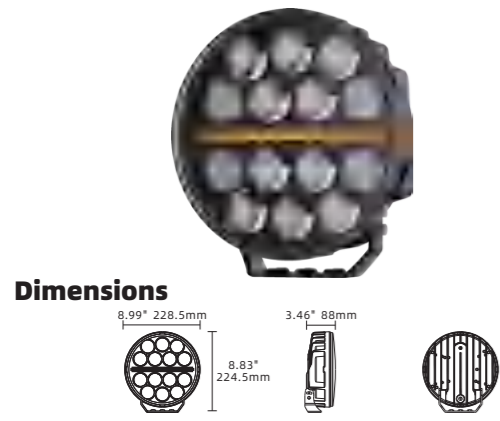

PART NO. 9R01

Parameter

Voltage	Power	LED Chios	Lm	Lux
9-36VDC	105W/12V@8.7A	3535*14pcs	14000LM	1lux@1010m

Material: Aluminum
 Color: White+Amber
 Beam pattern: Spot+DRL
 Cable: 55cm
 Waterproof rating: IP68/IP69K
 Dperating temperature: -40° C-85° C
 certificate: ROHS, CE,ECE
 Packing: 5Pcs/CTN(69×34.5×29.5cm)

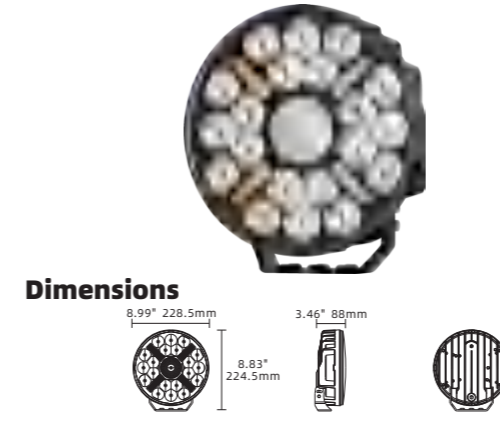

PART NO. 9R04

Parameter

Voltage	Power	LED Chios	Lm	Lux
9-36VDC	90.5W/12V@7.5A	3535*20pcs	20000LM	1lux@1385m

Material: Aluminum
 Color: White+Amber
 Beam pattern: Spot+DRL
 Cable: 55cm
 Waterproof rating: IP68/IP69K
 Dperating temperature: -40° C-85° C
 certificate: ROHS, CE,ECE
 Packing: 5Pcs/CTN(69×34.5×29.5cm)

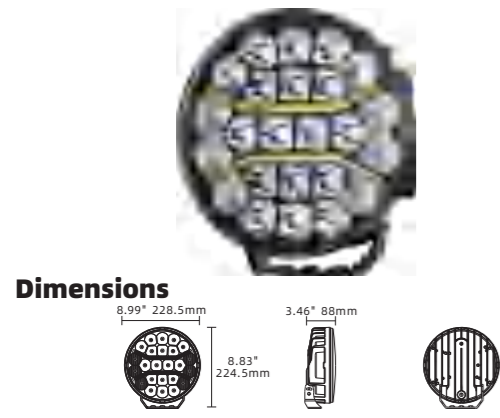

PART NO. 9R02

Parameter

Voltage	Power	LED Chios	Lm	Lux
9-36VDC	97W/12V@8A	3535*24pcs	24000LM	1lux@1296m

Material: Aluminum
 Color: White+Amber
 Beam pattern: Spot+DRL
 Cable: 55cm
 Waterproof rating: IP68/IP69K
 Dperating temperature: -40° C-85° C
 certificate: ROHS, CE,ECE
 Packing: 5Pcs/CTN(69×34.5×29.5cm)

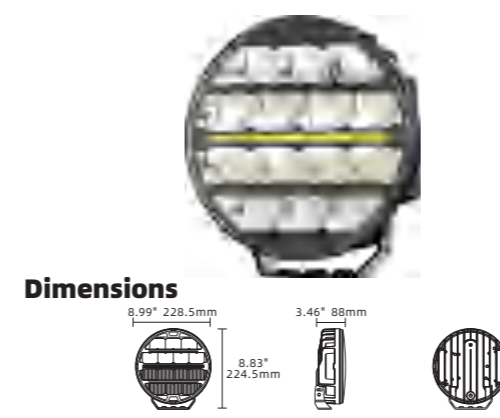

PART NO. 9R05

Parameter

Voltage	Power	LED Chios	Lm	Lux
9-36VDC	104W/12V@8.6A	3535*14pcs	14000LM	1lux@1133m

Material: Aluminum
 Color: White+Amber
 Beam pattern: Spot+DRL
 Cable: 55cm
 Waterproof rating: IP68/IP69K
 Dperating temperature: -40° C-85° C
 certificate: ROHS, CE,ECE
 Packing: 5Pcs/CTN(69×34.5×29.5cm)

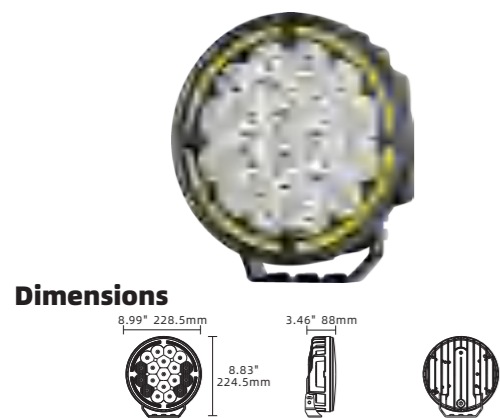

PART NO. 9R03

Parameter

Voltage	Power	LED Chios	Lm	Lux
9-36VDC	94W/12V@7.8A	3535*19pcs	19000LM	1lux@989m

Material: Aluminum
 Color: White+Amber
 Beam pattern: Spot+DRL
 Cable: 55cm
 Waterproof rating: IP68/IP69K
 Dperating temperature: -40° C-85° C
 certificate: ROHS, CE,ECE
 Packing: 5Pcs/CTN(69×34.5×29.5cm)



PART NO. 10C01

Parameter

Voltage	Power	LED Chios	Lm	Lux
9-36VDC	44.6W/12V@3.7A	3535*10pcs	10000LM	1lux@905m

Material: Aluminum
 Color: White+Amber
 Beam pattern: Spot+DRL
 Cable: 45cm
 Waterproof rating: IP68/IP69K
 Dperating temperature: -40° C-85° C
 certificate: ROHS.CE.
 Packing: 10Pcs/CTN(63×30.5×41.5cm)

Dimensions

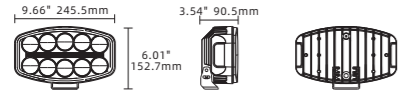

PART NO. 10C04

Parameter

Voltage	Power	LED Chios	Lm	Lux
9-36VDC	43W/12V@3.6A	3535*8pcs	12000LM	1lux@760m

Material: Aluminum
 Color: White+Amber
 Beam pattern: Spot+DRL
 Cable: 45cm
 Waterproof rating: IP68/IP69K
 Dperating temperature: -40° C-85° C
 certificate: ROHS.CE.
 Packing: 10Pcs/CTN(63×30.5×41.5cm)

Dimensions

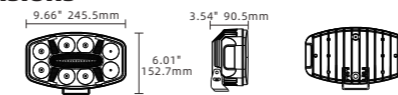

PART NO. 10C02

Parameter

Voltage	Power	LED Chios	Lm	Lux
9-36VDC	60W/12V@5A	3535*19pcs	19000LM	1lux@929m

Material: Aluminum
 Color: White+Amber
 Beam pattern: Spot+DRL
 Cable: 45cm
 Waterproof rating: IP68/IP69K
 Dperating temperature: -40° C-85° C
 certificate: ROHS.CE.
 Packing: 10Pcs/CTN(63×30.5×41.5cm)

Dimensions

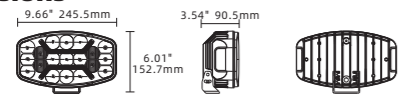

PART NO. 10C05

Parameter

Voltage	Power	LED Chios	Lm	Lux
9-36VDC	53.6W/12V@4.4A	3535*12pcs	12000LM	1lux@585m

Material: Aluminum
 Color: White+Amber
 Beam pattern: Spot+DRL
 Cable: 45cm
 Waterproof rating: IP68/IP69K
 Dperating temperature: -40° C-85° C
 certificate: ROHS.CE.
 Packing: 10Pcs/CTN(63×30.5×41.5cm)

Dimensions



PART NO. 10C03

Parameter

Voltage	Power	LED Chios	Lm	Lux
9-36VDC	57W/12V@4.75A	3535*12pcs	12000LM	1lux@885m

Material: Aluminum
 Color: White+Amber
 Beam pattern: Spot+DRL
 Cable: 45cm
 Waterproof rating: IP68/IP69K
 Dperating temperature: -40° C-85° C
 certificate: ROHS.CE.
 Packing: 10Pcs/CTN(63×30.5×41.5cm)

Dimensions

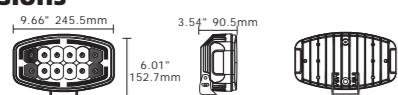

DXZ LED WORK LIGHTS



Dimensions

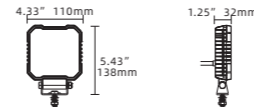

PART NO. 4C-F64F

Parameter

Voltage	Power	LED Chios	Lm	Lux
9-36VDC	24.8W/12V@2.05A	3030*64	6400LM	1lux@74m

Material: Aluminum
 Color: White
 Beam pattern: Flood
 Cable: 25cm
 Waterproof rating: IP68/IP69K
 Dperating temperature: -40° C-85° C
 certificate: ROHS, CE,ECE
 Packing: 50Pcs/CTN(68×27.5×32cm)

PART NO. 45C-F32F

Parameter

Voltage	Power	LED Chios	Lm	Lux
9-36VDC	24.8W/12V@2.04A	3030*32	3200LM	1lux@73m

Material: Aluminum
 Color: White
 Beam pattern: Flood
 Cable: 25cm
 Waterproof rating: IP68/IP69K
 Dperating temperature: -40° C-85° C
 certificate: ROHS, CE,ECE
 Packing: 50Pcs/CTN(68×27.5×32cm)

Dimensions

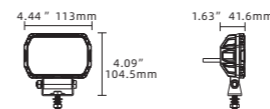

PART NO. 35C-F32F

Parameter

Voltage	Power	LED Chios	Lm	Lux
9-36VDC	25W/12V@2.08A	3030*32	3200LM	1lux@77m

Material: Aluminum
 Color: White
 Beam pattern: Flood
 Cable: 25cm
 Waterproof rating: IP68/IP69K
 Dperating temperature: -40° C-85° C
 certificate: ROHS, CE,ECE
 Packing: 50Pcs/CTN(68×27.5×32cm)

Dimensions

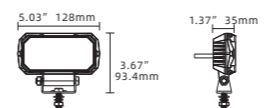

PART NO. 3C-BW-F-F4

Parameter

Voltage	Power	LED Chios	Lm	Lux
9-36VDC	15W/12V@1.24A	3030*16	3200LM	1lux@49m

Material: Aluminum
 Color: White
 Beam pattern: Flood
 Cable: 25cm
 Waterproof rating: IP68/IP69K
 Dperating temperature: -40° C-85° C
 certificate: ROHS, CE,ECE
 Packing: 50Pcs/CTN(58×24×27CM)

Dimensions

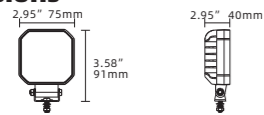

PART NO. 4C-Y32F

Parameter

Voltage	Power	LED Chios	Lm	Lux
9-36VDC	25W/12V@2.06A	3030*44	3200LM	1lux@77

Material: Aluminum
 Color: White
 Beam pattern: Flood
 Cable: 25cm
 Waterproof rating: IP68/IP69K
 Dperating temperature: -40° C-85° C
 certificate: ROHS, CE,ECE
 Packing: 50Pcs/CTN(68×27.5×32cm)

Dimensions

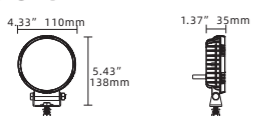

Dimensions

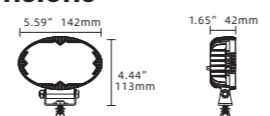

PART NO. 55C-T36F

Parameter

Voltage	Power	LED Chios	Lm	Lux
9-36VDC	25.7W/12V@2.12A	3030*36pcs	3600LM	1lux@72m

Material: Aluminum
 Color: White
 Beam pattern: Flood
 Cable: 25cm
 Waterproof rating: IP68/IP69K
 Dperating temperature: -40° C-85° C
 certificate: ROHS, CE,ECE
 Packing: 50Pcs/CTN(63×34×33cm)

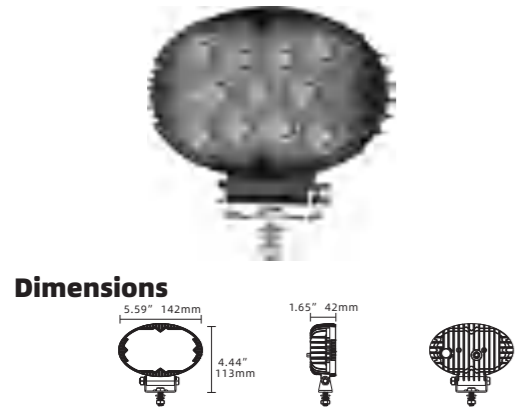

PART NO. 55C-T44F **Parameter**

Voltage	Power	LED Chios	Lm
9-36VDC	40W	3030*44	8800LM

Material: Aluminum
 Color: White
 Beam pattern: Flood
 Cable: 25cm
 Waterproof rating: IP68/IP69K
 Dperating temperature: -40° C-85° C
 certificate: ROHS.CE.
 Packing: 50Pcs/CTN(63x34x32cm)

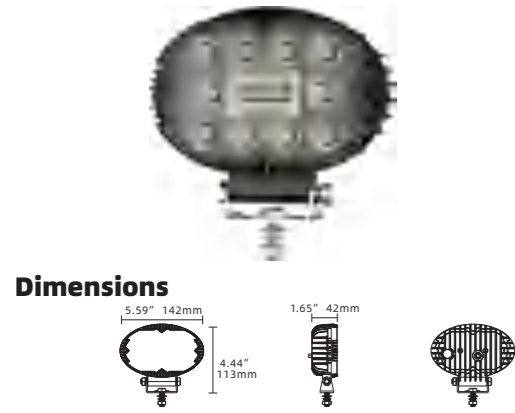

PART NO. 55C-T52F **Parameter**

Voltage	Power	LED Chios	Lm
9-32VDC	40W	3030*52	10400LM

Material: Aluminum
 Color: White+Yellow
 Beam pattern: Flood
 Cable: 25cm
 Waterproof rating: IP68/IP69K
 Dperating temperature: -40° C-85° C
 certificate: ROHS.CE.
 Packing: 50Pcs/CTN(63x34x32cm)

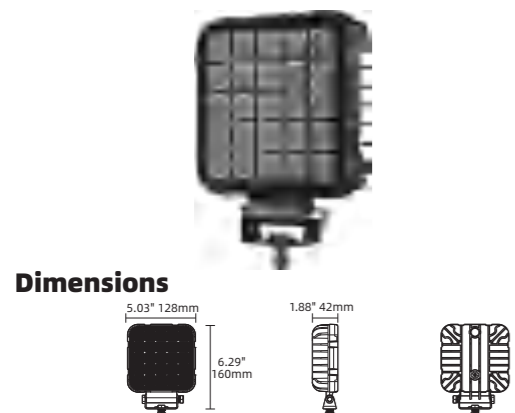

PART NO. 5C-BW-F-F25 **Parameter**

Voltage	Power	LED Chios	Lm
9-32VDC	40W/12V@3.36A	3030*100+8pcs	10800LM

Material: Aluminum
 Color: White+Yellow
 Beam pattern: Flood
 Cable: 25cm
 Waterproof rating: IP68/IP69K
 Dperating temperature: -40° C-85° C
 certificate: ROHS.CE.
 Packing: 20Pcs/CTN(38x33x29cm)

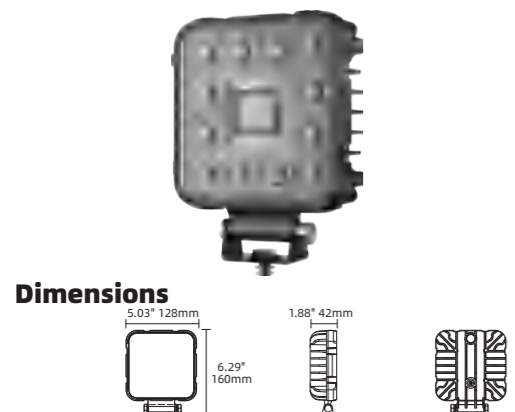

PART NO. 5C-F84F **Parameter**

Voltage	Power	LED Chios	Lm
9-36VDC	40W	3030*84pcs	8400LM

Material: Aluminum
 Color: White+Yellow
 Beam pattern: Flood
 Cable: 25cm
 Waterproof rating: IP68/IP69K
 Dperating temperature: -40° C-85° C
 certificate: ROHS.CE.
 Packing: 20Pcs/CTN(38x33x29cm)

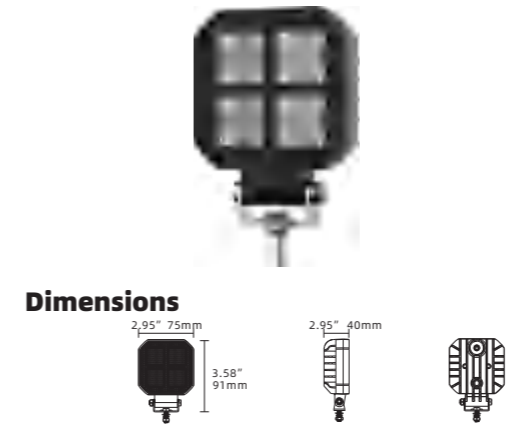

PART NO. 3C-BW-F-F16 **Parameter**

Voltage	Power	LED Chios	Lm	Lux
9-32VDC	14.81W/12V@1.23A	3030*16+4	3200LM	1lux@61m

Material: Aluminum
 Color: White+Yellow
 Beam pattern: Flood
 Cable: 25cm
 Waterproof rating: IP68/IP69K
 Dperating temperature: -40° C-85° C
 certificate: ROHS.CE.
 Packing: 50Pcs/CTN(67x27x34cm)

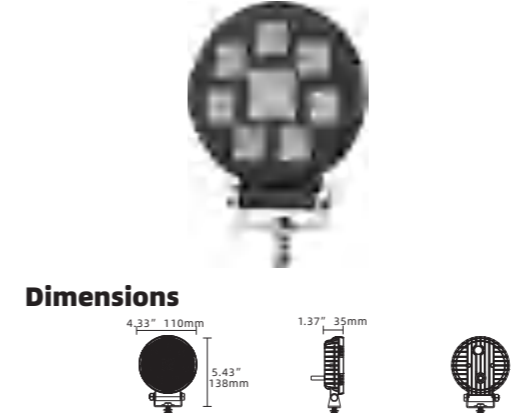

PART NO. 4C-BW-F-Y44 **Parameter**

Voltage	Power	LED Chios	Lm	Lux
9-32VDC	26W/12V@2.13A	3030*44+4	4800LM	1lux@90m

Material: Aluminum
 Color: White+Yellow
 Beam pattern: Flood
 Cable: 25cm
 Waterproof rating: IP68/IP69K
 Dperating temperature: -40° C-85° C
 certificate: ROHS.CE.
 Packing: 50Pcs/CTN(67x27x34cm)

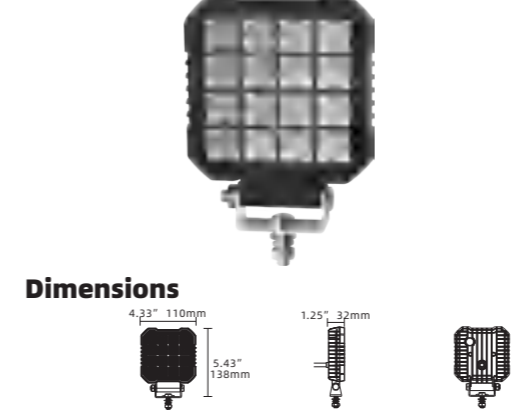

PART NO. 4C-BW-F-F64 **Parameter**

Voltage	Power	LED Chios	Lm	Lux
9-32VDC	White: 2A/12V-1A/24V Amber: 0.14A/12V-0.037A/24V	3030*64+4	6800LM	1lux@81m

Material: Aluminum
 Color: White+Yellow
 Beam pattern: Flood
 Cable: 25cm
 Waterproof rating: IP68/IP69K
 Dperating temperature: -40° C-85° C
 certificate: ROHS.CE.
 Packing: 50Pcs/CTN(67x27x34cm)

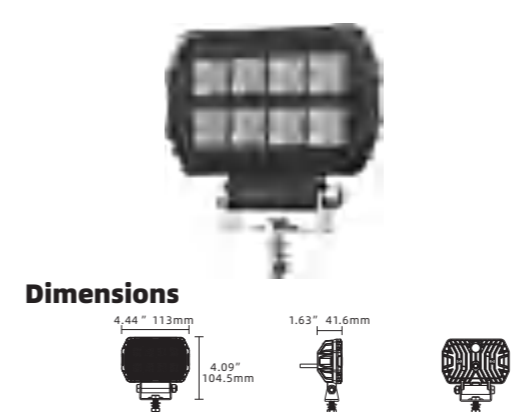

PART NO. 45C-BW-F-F32 **Parameter**

Voltage	Power	LED Chios	Lm	Lux
9-32VDC	25W/12V@2.1A	3030*32+3	3200LM	1lux@77m

Material: Aluminum
 Color: White+Yellow
 Beam pattern: Flood
 Cable: 25cm
 Waterproof rating: IP68/IP69K
 Dperating temperature: -40° C-85° C
 certificate: ROHS.CE.
 Packing: 50Pcs/CTN(67x27x34cm)

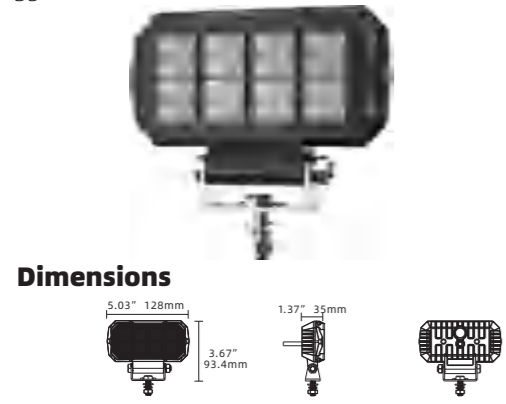

Dimensions

PART NO. 35C-BW-F-F29 **Parameter**

Voltage	Power	LED Chios	Lm	Lux
9-32VDC	24W/12V@1.97A	3030*32+3	3500LM	1lux@78m

Material: Aluminum
 Color: White+Yellow
 Beam pattern: Flood
 Cable: 25cm
 Waterproof rating: IP68/IP69K
 Dperating temperature: -40° C-85° C
 certificate: ROHS.CE.
 Packing: 50Pcs/CTN(67x27x34cm)

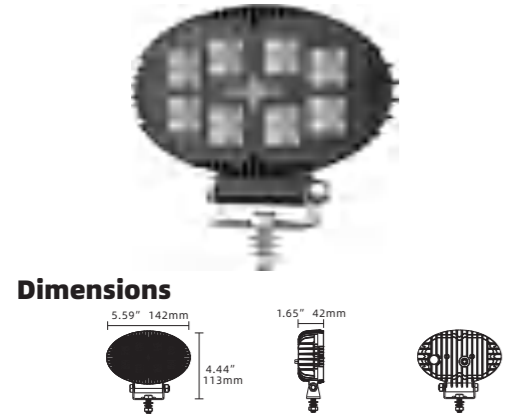

Dimensions

PART NO. 55C-BW-F-T36 **Parameter**

Voltage	Power	LED Chios	Lm	Lux
9-32VDC	24W/12V@2A	3030*32+4	4000LM	1lux@79m

Material: Aluminum
 Color: White+Yellow
 Beam pattern: Flood
 Cable: 25cm
 Waterproof rating: IP68/IP69K
 Dperating temperature: -40° C-85° C
 certificate: ROHS.CE.
 Packing: 50Pcs/CTN(67x27x34cm)

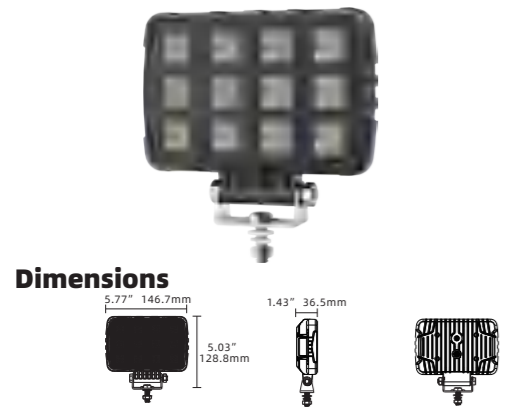

Dimensions

PART NO. 57C-BW-F-F48 **Parameter**

Voltage	Power	LED Chios	Lm	Lux
9-32VDC	24.9W/12V@2.05A	3030*48+4	5200LM	1lux@81m

Material: Aluminum
 Color: White+Yellow
 Beam pattern: Flood
 Cable: 25cm
 Waterproof rating: IP68/IP69K
 Dperating temperature: -40° C-85° C
 certificate: ROHS.CE.
 Packing: 50Pcs/CTN(35x27x32.5cm)

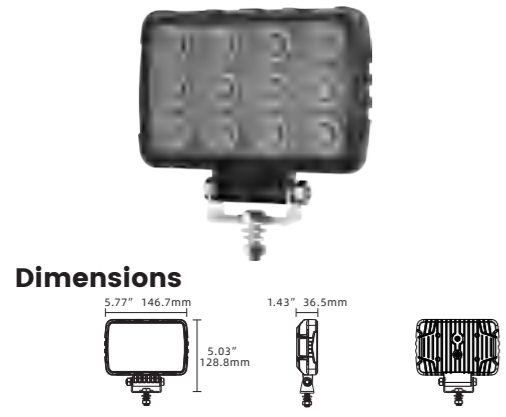

Dimensions

PART NO. 57C-F48F **Parameter**

Voltage	Power	LED Chios	Lm	Lux
9-36VDC	24.9W/12V@2.05A	3030*48pcs	4800LM	1lux@78m

CMaterial: Aluminum
 olor: White
 Beam pattern: Flood
 Cable: 25cm
 Waterproof rating: IP68/IP69K
 Dperating temperature: -40° C-85° C
 certificate: ROHS. CE.ECE
 Packing: 20Pcs/CTN(35x27x32.5cm)



PART NO. 4C-ZB-F

PART NO. 5C-ZB-F

PART NO. 6C-ZB-F



PART NO. 4C-ZB-Y

PART NO. 5C-ZB-Y

PART NO. 6C-ZB-Y

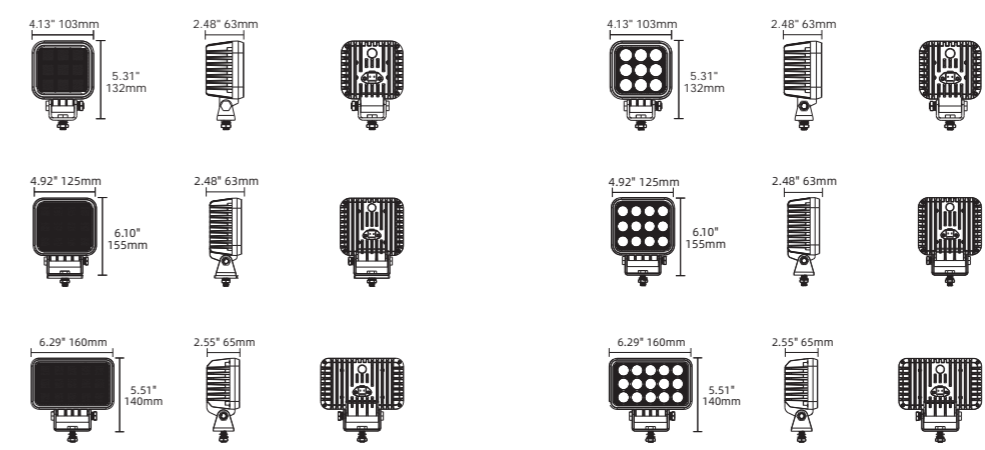

PART NO.	4C-ZB-F	5C-ZB-F	6C-ZB-F	4C-ZB-Y	5C-ZB-Y	6C-ZB-Y
Voltage	9-36VDC	9-36VDC	9-36VDC	9-36VDC	9-36VDC	9-36VDC
Power	40W	40W	60W	60W	80W	80W
LED Chios	3030*36pcs	3030*48pcs	3030*60pcs	3030*36pcs	3030*48pcs	3030*60pcs
LM	1200LM	2400LM	3000LM	1200LM	2400LM	3000LM

Material: Aluminum
 Color: White
 Beam pattern: Flood
 Cable: 25m
 Waterproof rating: IP68/IP69K
 Dperating temperature: -40° C-85° C
 certificate: ROHS.CE.ECE
 Packing: //

OEM CUSTOMIZATION



Minimalist aluminum shell combines premium aesthetics with long-lasting durability. Custom silk-screen printing is offered, whether for a team logo or a personalized slogan.

Powerful floodlight delivers even illumination, adapting to a wide range of scenarios.



PART NO. 4C-BQ-Y



PART NO. 4C-BQ-F



PART NO. 55C-BQ-T

Dimensions

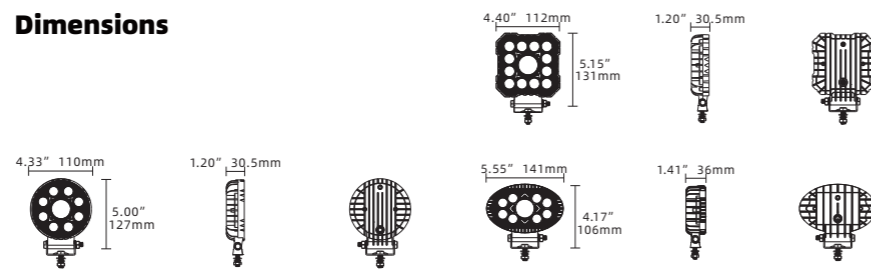

Parameter

PART NO.	4C-BQ-Y	4C-BQ-F	55C-BQ-T
Voltage	9-36VDC	9-36VDC	9-36VDC
Power	14.4W/12V@1.2A	13.7W/12V@1.13A	18.6W/12V@1.55A
LED Chips	3030*8pcs	3030*12pcs	3030*8pcs
LM	1600LM	2400LM	2000LM
Lux	1 lux@239m	1 lux@189m	1 lux@229m

Material: Aluminum
 Color: White
 Beam pattern: Spot
 Cable: 26cm
 Waterproof rating: IP68/IP69K
 Operating temperature: -40° C-85° C
 certificate: ROHS,CE.
 Packing: 50Pcs/CTN(68x27.5x32cm)

Parameter



Dimensions



Parameter

PART NO.	4C-SQ-F1	4C-SQ-F3	4C-SQ-F2	4C-SQ-Y1	4C-SQ-Y3	4C-SQ-Y2
Voltage	9-36VDC	9-36VDC	9-36VDC	9-36VDC	9-36VDC	9-36VDC
Power	15.1W/12V@1.25A	14W/12V@1.2A	15.4W/12V@1.27A	15W/12V@1.23A	14.7W/12V@1.2A	14.8W/12V@1.2A
LED Chips	3030*64pcs	3030*100pcs	3030*72pcs	3030*48pcs	3030*44pcs	3030*96pcs
LM	6400LM	10000M	7200LM	4800LM	4400LM	9600LM
Lux	1 lux@72m	1 lux@54m	1 lux@54m	1 lux@60m	1 lux@60m	1 lux@50m

Material: Aluminum
 Color: White+Amber
 Beam pattern: Flood
 Cable: 26cm
 Waterproof rating: IP68/IP69K
 Operating temperature: -40° C-85° C
 certificate: ROHS,CE.
 Packing: 50Pcs/CTN(68x27.5x32cm)



PART NO. 4C-SQ-F1



PART NO. 4C-SQ-F3



PART NO. 4C-SQ-F2



PART NO. 4C-SQ-Y1



PART NO. 4C-SQ-Y3



PART NO. 4C-SQ-Y2

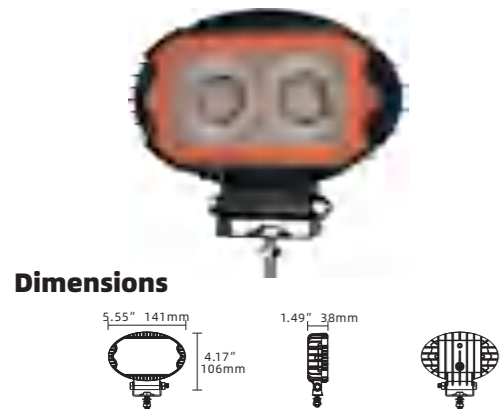

PART NO. 55C-SQ-T1 **Parameter**

Voltage	Power	LED Chios	Lm	Lux
9-36VDC	16W/12V@1.3A	3030*32+22PCS	9600LM	1lux@68m

Material: Aluminum
 Color: White+Amber
 Beam pattern: Flood
 Cable: 26cm
 Waterproof rating: IP68/IP69K
 Dperating temperature: -40° C-85° C
 certificate: ROHS.CE.
 Packing: 50Pcs/CTN(68×27.5×32CM)

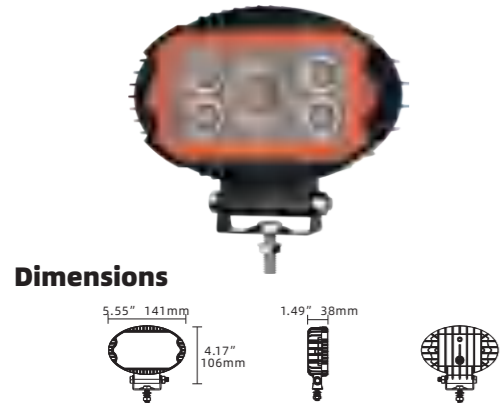

PART NO. 55C-SQ-T2 **Parameter**

Voltage	Power	LED Chios	Lm	Lux
9-36VDC	16W/12V@1.3A	3030*25+22PCS	9600LM	1lux@58m

Material: Aluminum
 Color: White+Amber
 Beam pattern: Flood
 Cable: 26cm
 Waterproof rating: IP68/IP69K
 Dperating temperature: -40° C-85° C
 certificate: ROHS.CE.
 Packing: 50Pcs/CTN(68×27.5×32CM)

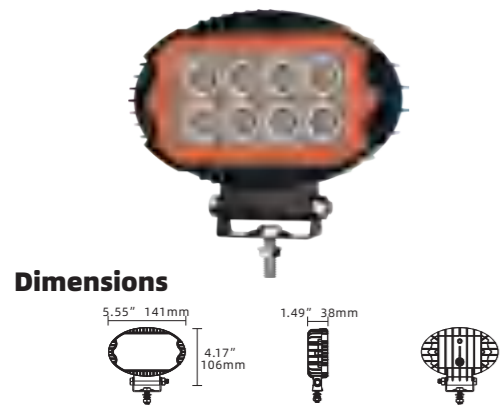

PART NO. 55C-SQ-T3 **Parameter**

Voltage	Power	LED Chios	Lm	Lux
9-36VDC	15.5W/12V@1.28A	3030*32+22PCS	9600LM	1lux@57m

Material: Aluminum
 Color: White+Amber
 Beam pattern: Flood
 Cable: 26cm
 Waterproof rating: IP68/IP69K
 Dperating temperature: -40° C-85° C
 certificate: ROHS.CE.
 Packing: 50Pcs/CTN(68×27.5×32CM)



PART NO. 55C-SQ-T5 **Parameter**

Voltage	Power	LED Chios	Lm	Lux
9-36VDC	16.5W/12V@1.36A	3030*32+22PCS	9600LM	1lux@62m

Material: Aluminum
 Color: White+Amber
 Beam pattern: Flood
 Cable: 26cm
 Waterproof rating: IP68/IP69K
 Dperating temperature: -40° C-85° C
 certificate: ROHS.CE.
 Packing: 50Pcs/CTN(68×27.5×32CM)

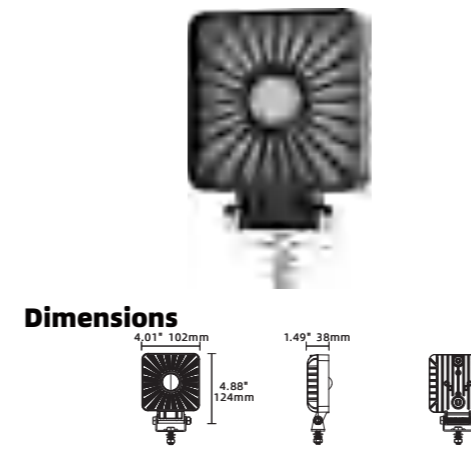

PART NO. 4C-F1-RGB **Parameter**

Voltage	Power	LED Chios	Lm	Lux
9-36VDC	16.6W/12V@1.38A	3570*1PCS	4500LM	1lux@296m

Material: Aluminum
 Color: RGB
 Beam pattern: Spot
 Cable: 26cm
 Waterproof rating: IP68/IP69K
 Dperating temperature: -40° C-85° C
 certificate: ROHS.CE.
 Packing: 50Pcs/CTN(68×27.5×32cm)

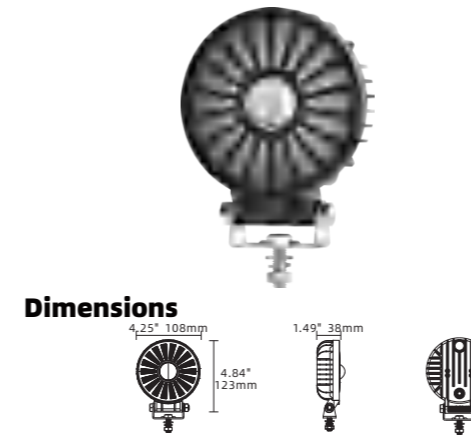

PART NO. 4C-Y1-RGB **Parameter**

Voltage	Power	LED Chios	Lm	Lux
9-36VDC	15.4W/12V@1.27A	3570*1PCS	4500LM	1lux@281m

Material: Aluminum
 Color: RGB
 Beam pattern: Spot
 Cable: 26cm
 Waterproof rating: IP68/IP69K
 Dperating temperature: -40° C-85° C
 certificate: ROHS.CE.
 Packing: 50Pcs/CTN(68×27.5×32cm)

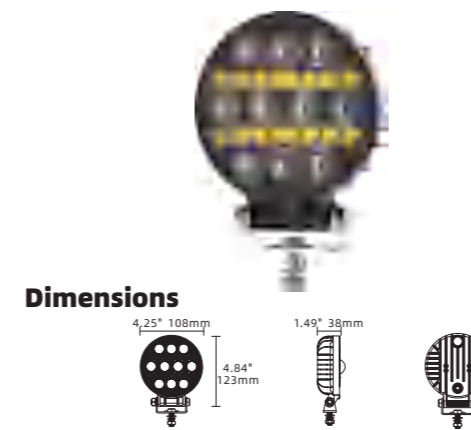

PART NO. 4C-BW-37Y **Parameter**

Voltage	Power	LED Chios	Lm	Lux
9-36VDC	16.7W/12V@1.38A	3030*10	2000LM	1lux@258m

Material: Aluminum
 Color: White+Amber
 Beam pattern: Spot+DRL
 Cable: 26cm
 Waterproof rating: IP68/IP69K
 Dperating temperature: -40° C-85° C
 certificate: ROHS. CE.ECE
 Packing: 50Pcs/CTN(68×27.5×32cm)

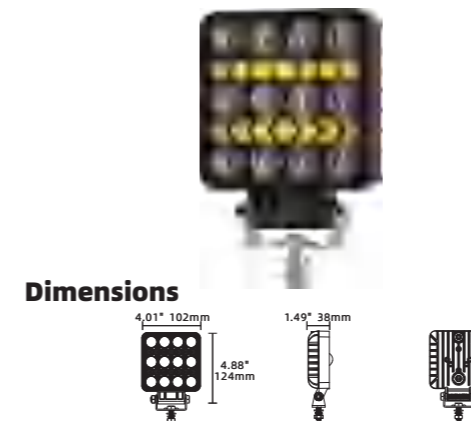

PART NO. 4C-BW-37F **Parameter**

Voltage	Power	LED Chios	Lm	Lux
9-36VDC	16.5W/12V@1.36A	3030*12PCS	1200LM	1lux@239m

Material: Aluminum
 Color: White+Amber
 Beam pattern: Spot+DRL
 Cable: 26cm
 Waterproof rating: IP68/IP69K
 Dperating temperature: -40° C-85° C
 certificate: ROHS. CE.ECE
 Packing: 50Pcs/CTN(68×27.5×32cm)

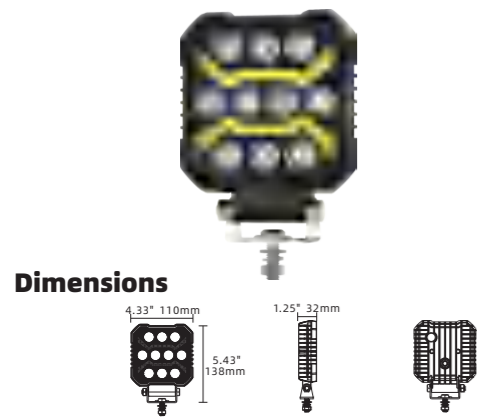

PART NO. 4C-BW-F10 **Parameter**

Voltage	Power	LED Chios	Lm	Lux
9-36VDC	White: 1.45A/12V-0.71A/24V Amber: 0.26A/12V-0.13A/24V	3535*10PCS	4500LM	1lux@321m

Material: Aluminum
 Color: White+Amber
 Beam pattern: Spot+DRL
 Cable: 26cm
 Waterproof rating: IP68/IP69K
 Dperating temperature: -40° C-85° C
 certificate: ROHS, CE.ECE
 Packing: 50Pcs/CTN(68×27.5×32cm)

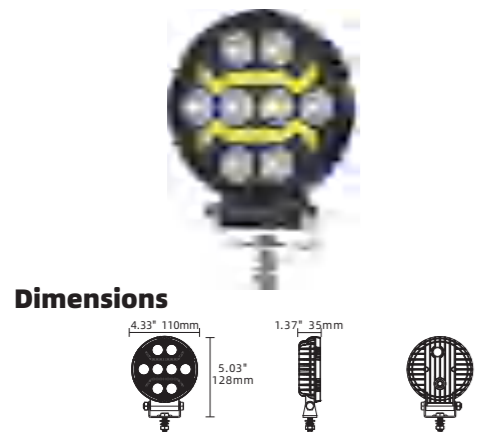

PART NO. 4C-BW-Y8 **Parameter**

Voltage	Power	LED Chios	Lm	Lux
9-36VDC	White: 1.24A/12V-0.6A/24V Amber: 0.25A/12V-0.13A/24V	3535*8	3600LM	1lux@321m

Material: Aluminum
 Color: White+Amber
 Beam pattern: Spot+DRL
 Cable: 26cm
 Waterproof rating: IP68/IP69K
 Dperating temperature: -40° C-85° C
 certificate: ROHS, CE.ECE
 Packing: 50Pcs/CTN(68×27.5×32cm)

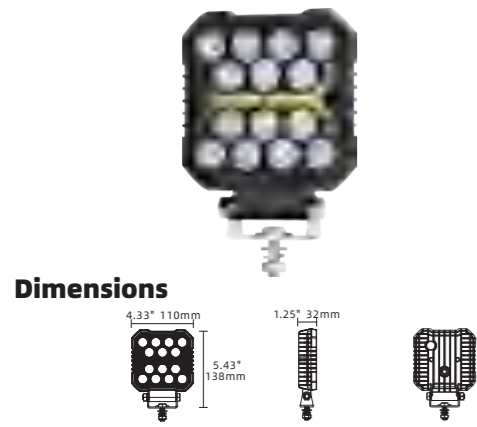

PART NO. 4C-BW-F14 **Parameter**

Voltage	Power	LED Chios	Lm	Lux
9-36VDC	16.7W/12V@*1.4A	3030*14PCS	1400LM	1lux@331m

Material: Aluminum
 Color: White+Amber
 Beam pattern: Spot+DRL
 Cable: 26cm
 Waterproof rating: IP68/IP69K
 Dperating temperature: -40° C-85° C
 certificate: ROHS, CE.ECE
 Packing: 50Pcs/CTN(68×27.5×32cm)



PART NO. 4C-BW-Y12 **Parameter**

Voltage	Power	LED Chios	Lm	Lux
9-36VDC	18W/12V@1.5A	3030*12	3600LM	1lux@296m

Material: Aluminum
 Color: White+Amber
 Beam pattern: Spot+DRL
 Cable: 26cm
 Waterproof rating: IP68/IP69K
 Dperating temperature: -40° C-85° C
 certificate: ROHS, CE.ECE
 Packing: 50Pcs/CTN(68×27.5×32cm)

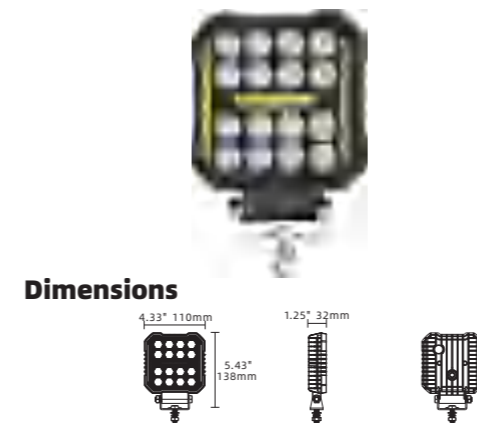

PART NO. 4C-BW-F16 **Parameter**

Voltage	Power	LED Chios	Lm	Lux
9-36VDC	17.3W/12V@*1.44A	3030*16PCS	1600LM	1lux@285m

Material: Aluminum
 Color: White+Amber
 Beam pattern: Spot+DRL
 Cable: 26cm
 Waterproof rating: IP68/IP69K
 Dperating temperature: -40° C-85° C
 certificate: ROHS, CE.ECE
 Packing: 50Pcs/CTN(68×27.5×32cm)

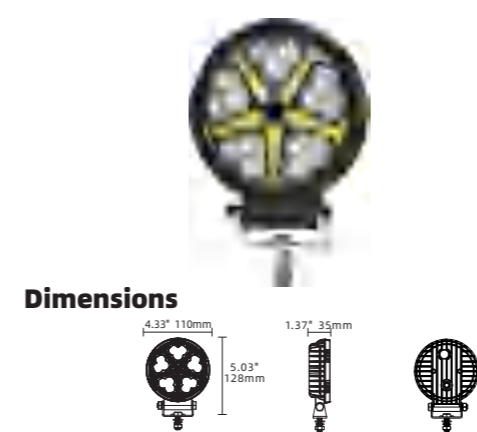

PART NO. 4C-BW-Y15 **Parameter**

Voltage	Power	LED Chios	Lm	Lux
9-36VDC	17.9W/12V@1.48A	3030*15	3600LM	1lux@241m

Material: Aluminum
 Color: White+Amber
 Beam pattern: Spot+DRL
 Cable: 26cm
 Waterproof rating: IP68/IP69K
 Dperating temperature: -40° C-85° C
 certificate: ROHS, CE.ECE
 Packing: 50Pcs/CTN(68×27.5×32cm)

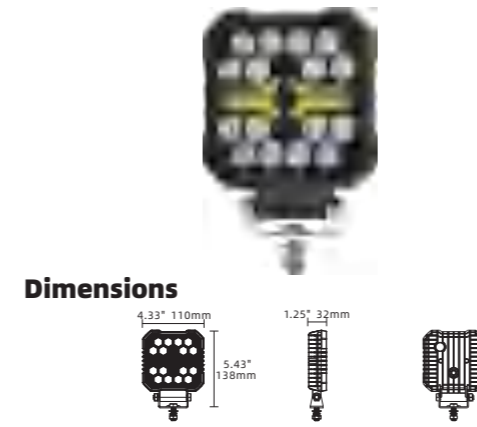

PART NO. 4C-BW-F16-JT **Parameter**

Voltage	Power	LED Chios	Lm	Lux
9-36VDC	18.8W/12V@1.56A	3030*16PCS	1600LM	1lux@276m

Material: Aluminum
 Color: White+Amber
 Beam pattern: Spot+DRL
 Cable: 26cm
 Waterproof rating: IP68/IP69K
 Dperating temperature: -40° C-85° C
 certificate: ROHS, CE.ECE
 Packing: 50Pcs/CTN(68×27.5×32cm)

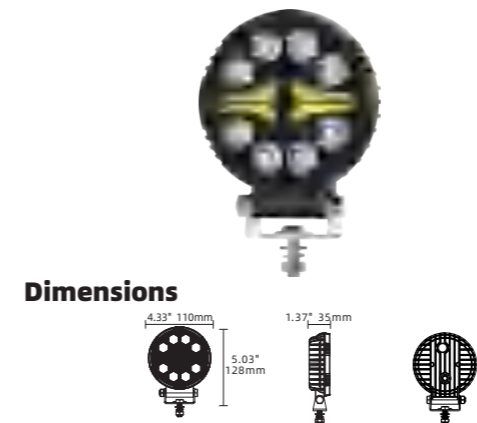

PART NO. 4C-BW-Y8-JT **Parameter**

Voltage	Power	LED Chios	Lm	Lux
9-36VDC	16.2W/12V@1.34A	3030*8PCS	1600LM	1lux@256m

Material: Aluminum
 Color: White+Amber
 Beam pattern: Spot+DRL
 Cable: 26cm
 Waterproof rating: IP68/IP69K
 Dperating temperature: -40° C-85° C
 certificate: ROHS, CE.ECE
 Packing: 50Pcs/CTN(68×27.5×32cm)



Dimensions

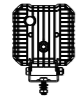
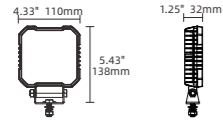

PART NO. 4C-BW-F12-X **Parameter**

Voltage	Power	LED Chios	Lm	Lux
9-36VDC	18.8W/12V@1.56A	3030*12PCS	2400LM	1lux@312m

Material: Aluminum
 Color: White+Amber
 Beam pattern: Spot+DRL
 Cable: 26cm
 Waterproof rating: IP68/IP69K
 Dperating temperature: -40° C-85° C
 certificate: ROHS, CE,ECE
 Packing: 50Pcs/CTN(68×27.5×32cm)



Dimensions

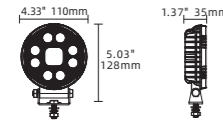

PART NO. 4C-BW-Y12-X **Parameter**

Voltage	Power	LED Chios	Lm	Lux
9-36VDC	18.8W/12V@1.56A	3030*12	2400LM	1lux@287m

Material: Aluminum
 Color: White+Amber
 Beam pattern: Spot+DRL
 Cable: 26cm
 Waterproof rating: IP68/IP69K
 Dperating temperature: -40° C-85° C
 certificate: ROHS, CE,ECE
 Packing: 50Pcs/CTN(68×27.5×32cm)



Dimensions

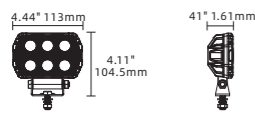

PART NO. 45C-BW-F6 **Parameter**

Voltage	Power	LED Chios	Lm	Lux
9-30VDC	25.5W/12V@2.12A	3535*6	2700LM	1lux@396m

Material: Aluminum
 Color: White+Amber
 Beam pattern: Spot+DRL
 Cable: 27cm
 Waterproof rating: IP68/IP69K
 Dperating temperature: -40° C-85° C
 certificate: ROHS, CE,ECE
 Packing: 50Pcs/CTN(68×27.5×32cm)



Dimensions

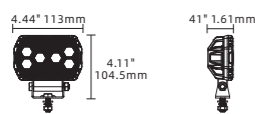

PART NO. 45C-BW-F6X **Parameter**

Voltage	Power	LED Chios	Lm	Lux
9-36VDC	24W/12V@2A	3535*6	2700LM	1lux@304m

Material: Aluminum
 Color: White+Amber
 Beam pattern: Spot+DRL
 Cable: 27cm
 Waterproof rating: IP68/IP69K
 Dperating temperature: -40° C-85° C
 certificate: ROHS, CE,ECE
 Packing: 50Pcs/CTN(68×27.5×32cm)



Dimensions

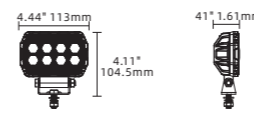

PART NO. 45C-BW-F8 **Parameter**

Voltage	Power	LED Chios	Lm	Lux
9-36VDC	25.5W/12V@2.12A	3535*8	3600LM	1lux@306m

Material: Aluminum
 Color: White+Amber
 Beam pattern: Spot+DRL
 Cable: 27cm
 Waterproof rating: IP68/IP69K
 Dperating temperature: -40° C-85° C
 certificate: ROHS, CE,ECE
 Packing: 50Pcs/CTN(68×27.5×32cm)



Dimensions

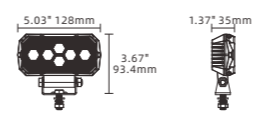

PART NO. 5C-BW-F6 **Parameter**

Voltage	Power	LED Chios	Lm	Lux
9-36VDC	White: 1.95A/12V-1A/24V Amber: 0.23A/12V-0.12A24V	3535*6	2700LM	1lux@259m

Material: Aluminum
 Color: White+Amber
 Beam pattern: Spot+DRL
 Cable: 27cm
 Waterproof rating: IP68/IP69K
 Dperating temperature: -40° C-85° C
 certificate: ROHS, CE,ECE
 Packing: 50Pcs/CTN(68×27.5×32cm)



Dimensions

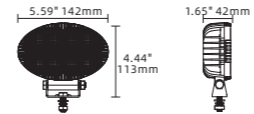

PART NO. 55C-BW-T8 **Parameter**

Voltage	Power	LED Chios	Lm	Lux
9-36VDC	19W/12V@1.6A	3030*8pcs	1600LM	1lux@80m

Material: Aluminum
 Color: White+Amber
 Beam pattern: Spot+DRL
 Cable: 27cm
 Waterproof rating: IP68/IP69K
 Dperating temperature: -40° C-85° C
 certificate: ROHS, CE,ECE
 Packing: 50Pcs/CTN(63*34*33cm)



Dimensions

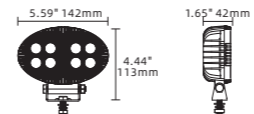

PART NO. 55C-BW-T8X **Parameter**

Voltage	Power	LED Chios	Lm	Lux
9-36VDC	19W/12V@1.6A	3030*8pcs	1600LM	1lux@319m

Material: Aluminum
 Color: White+Amber
 Beam pattern: Spot+DRL
 Cable: 27cm
 Waterproof rating: IP68/IP69K
 Dperating temperature: -40° C-85° C
 certificate: ROHS, CE,ECE
 Packing: 50Pcs/CTN(63*34*33cm)



Dimensions

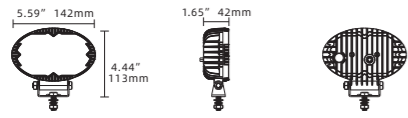

PART NO. 55C-BW-T9

Parameter

Voltage	Power	LED Chios	Lm	Lux
9-36VDC	White: 1.73A/12V-0.86A/24V Amber: 0.16A/12V-0.07A/24V	3030*9pcs	1800LM	1lux@82m

Material: Aluminum
 Color: White+Amber
 Beam pattern: Spot+DRL
 Cable: 27cm
 Waterproof rating: IP68/IP69K
 Dperating temperature: -40° C-85° C
 certificate: ROHS, CE,ECE
 Packing: 50Pcs/CTN(63*34*33cm)



Dimensions

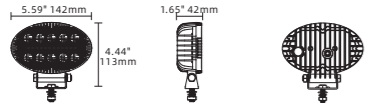

PART NO. 55C-BW-T10

Parameter

Voltage	Power	LED Chios	Lm	Lux
9-36VDC	18W/12V@1.5A	3030*10pcs	2000LM	1lux@73m

Material: Aluminum
 Color: White+Amber
 Beam pattern: Spot+DRL
 Cable: 27cm
 Waterproof rating: IP68/IP69K
 Dperating temperature: -40° C-85° C
 certificate: ROHS, CE,ECE
 Packing: 50Pcs/CTN(63*34*33cm)



Dimensions

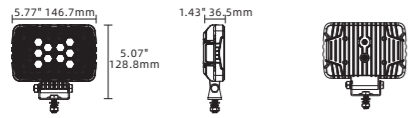

PART NO. 57C-BW-18

Parameter

Voltage	Power	LED Chios	Lm	Lux
9-36VDC	34W/12V@2.8A	3030*18	3600LM	1lux@266m

Material: Aluminum
 Color: White+Amber
 Beam pattern: Spot+DRL
 Cable: 37cm
 Waterproof rating: IP68/IP69K
 Dperating temperature: -40° C-85° C
 certificate: ROHS, CE,ECE
 Packing: 20Pcs/CTN(35*27*32.5cm)



Dimensions

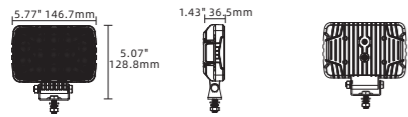

PART NO. 57C-BW-9

Parameter

Voltage	Power	LED Chios	Lm	Lux
9-36VDC	38W/12V@3.1A	3030*9	1800LM	1lux@117m

Material: Aluminum
 Color: White+Amber
 Beam pattern: Spot+DRL
 Cable: 37cm
 Waterproof rating: IP68/IP69K
 Dperating temperature: -40° C-85° C
 certificate: ROHS, CE,ECE
 Packing: 20Pcs/CTN(35*27*32.5cm)



Dimensions

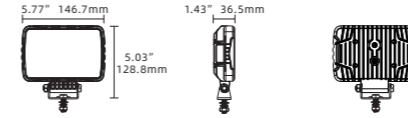

PART NO. 57C-BW-11

Parameter

Voltage	Power	LED Chios	Lm	Lux
9-36VDC	38W/12V@3.1A	3030*9	2200LM	1lux@110m

Material: Aluminum
 Color: White+Amber
 Beam pattern: Spot+DRL
 Cable: 37cm
 Waterproof rating: IP68/IP69K
 Dperating temperature: -40° C-85° C
 certificate: ROHS, CE,ECE
 Packing: 20Pcs/CTN(35*27*32.5cm)

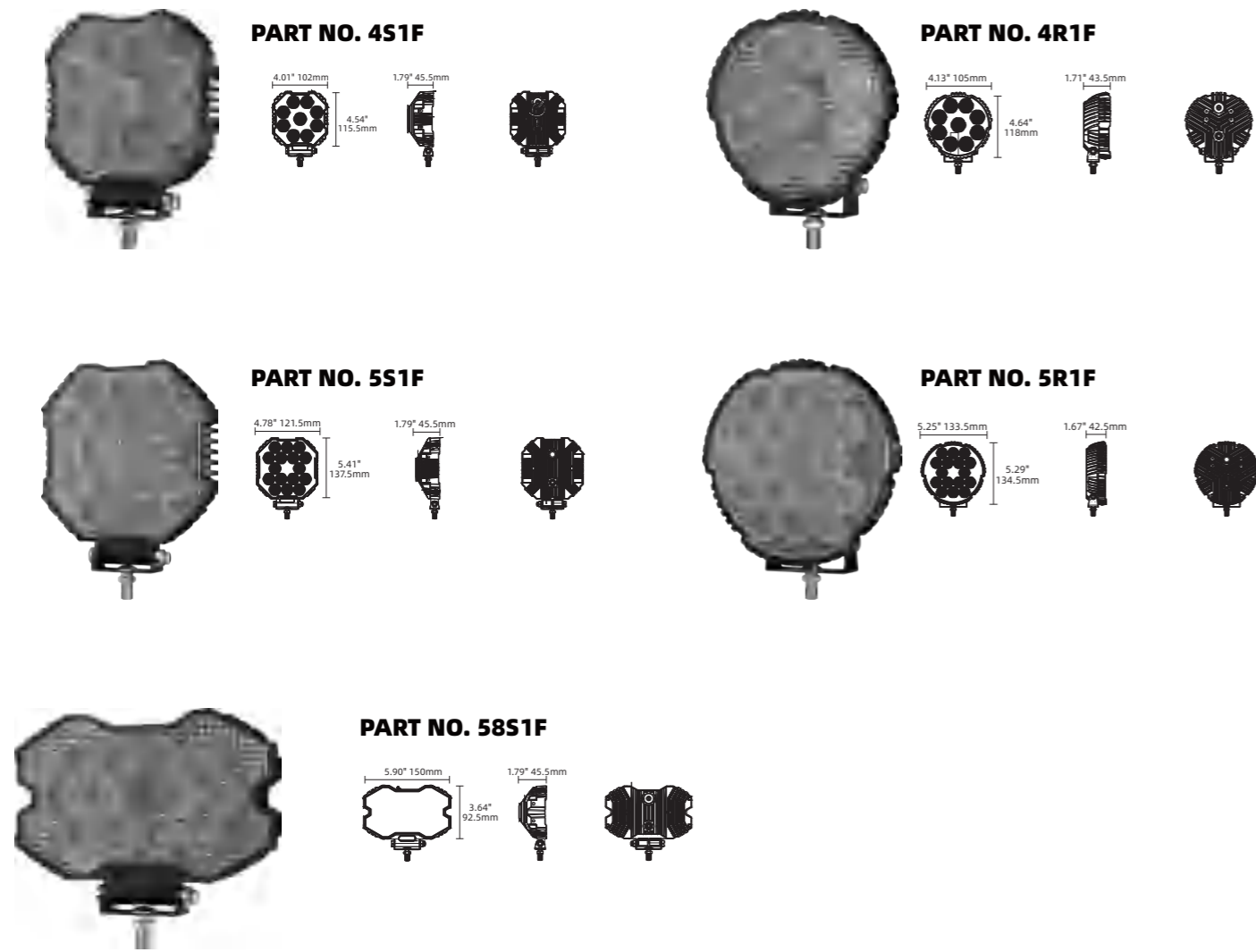

PART NO.	4S1F	4R1F	5S1F	5R1F	58S1F
Material	Aluminum				
Voltage	9-30V DC				
LED Chips	1 lux@438m		1 lux@438m		1 lux@390m
Power	16W/12V@1.33A	24.5W/12V@2.02A	26W/12V@2.16A	41.5W/12V@3.42A	22W/12V@1.83A
LM	2700LM		4800LM		3600LM
Lux	1 lux@438m	1 lux@344m	1 lux@476m	1 lux@555m	1 lux@390m
Color	White				
Beam pattern	Flood				
Cable	37cm				
Waterproof rating	IP68/IP69K				
Operating temperature	-40°C -85°C				
Certificate	ROHS. CE.				
Packing	20Pcs/CTN(38×28×38cm)		20Pcs/CTN(43×31×38cm)		20Pcs/CTN(38×35×38cm)

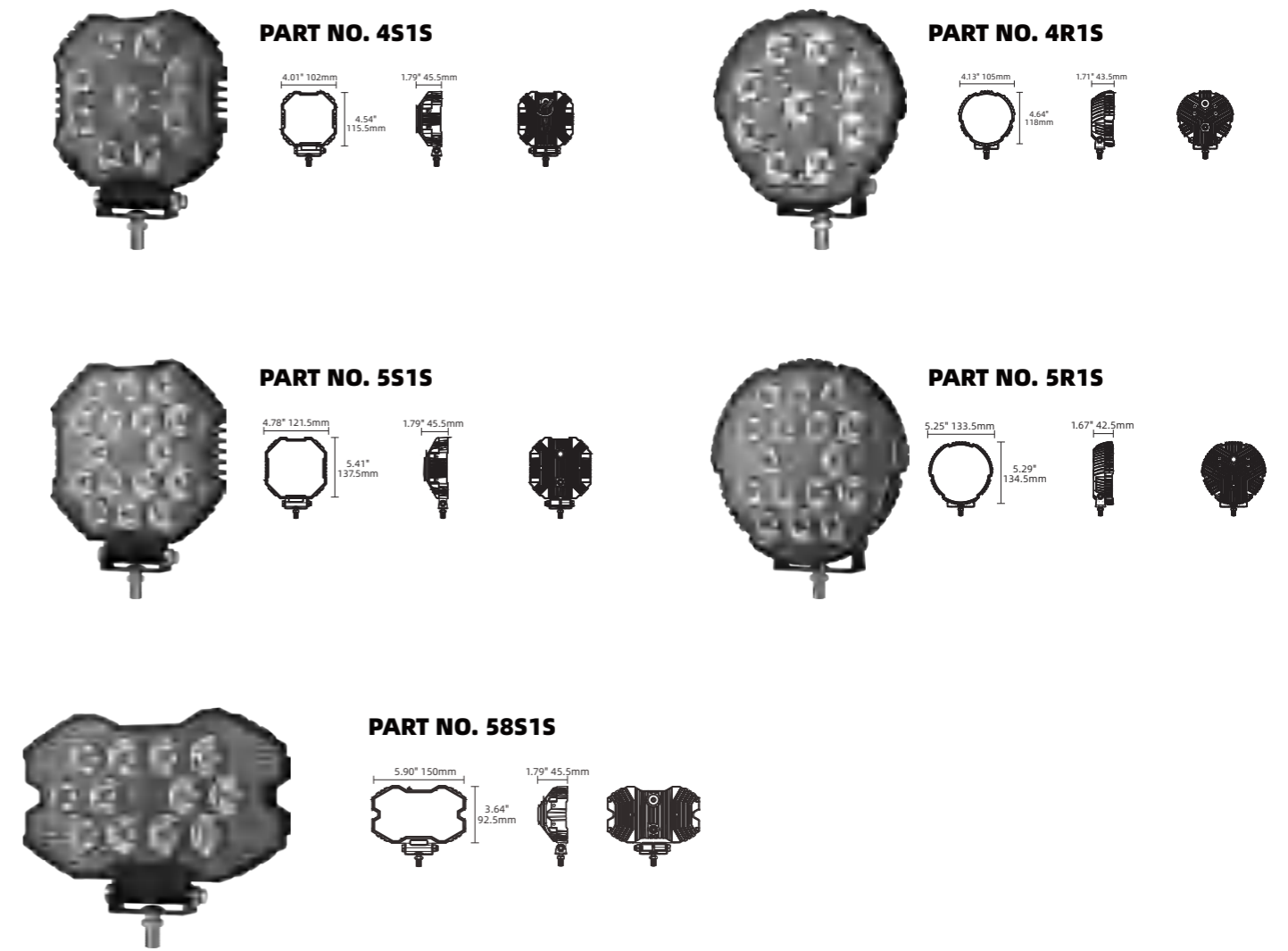

PART NO.	4S1S	4R1S	5S1S	5R1S	58S1S
Material	Aluminum				
Voltage	9-30V DC				
LED Chips	1 lux@438m		1 lux@438m		1 lux@390m
Power	16W/12V@1.33A	24.5W/12V@2.02A	26W/12V@2.16A	41.5W/12V@3.42A	22W/12V@1.83A
LM	2700LM		4800LM		3600LM
Lux	1 lux@438m	1 lux@344m	1 lux@476m	1 lux@555m	1 lux@390m
Color	White				
Beam pattern	Spot				
Cable	37cm				
Waterproof rating	IP68/IP69K				
Operating temperature	-40°C -85°C				
Certificate	ROHS. CE.				
Packing	20Pcs/CTN(38×28×38cm)		20Pcs/CTN(43×31×38cm)		20Pcs/CTN(38×35×38cm)

LED MOTORCYCLE LIGHTS



Dimensions

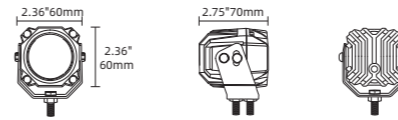

PART NO. M-F1-R-W5

Parameter

Voltage	Power	LED Chios	Life	Lux
12-60VDC	1.65A [1pcs 1.5A]	3570*1	50000H	1lux@291m

Material: Aluminum
 Color: White+Golden
 Beam pattern: Spot
 Cable: 3m
 Waterproof rating: IP68/IP69K
 Dperating temperature: -40° C-85° C
 certificate: ROHS.CE.
 Packing: 10Set/CTN(56x41x2cm)



Dimensions

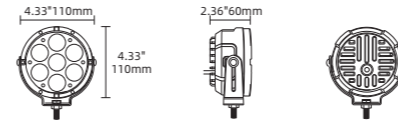

PART NO. KIT-M-N-7S-XS

Parameter

Voltage	Power	LED Chios	Life
9-80VDC	9.6A [1pcs 4.9A]	3535*7	50000H

Material: Aluminum
 Color: White
 Beam pattern: Spot
 Cable: 3m
 Waterproof rating: IP68/IP69K
 Dperating temperature: -40° C-85° C
 certificate: ROHS.CE.
 Packing: 5Set/CTN(46.5x34x27.5cm)



Dimensions

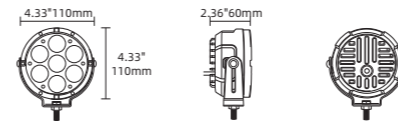

PART NO. KIT-M-N-7F-XS

Parameter

Voltage	Power	LED Chios	Life
9-80VDC	9.6A [1pcs 5A]	3535*7	50000H

Material: Aluminum
 Color: White
 Beam pattern: Spot
 Cable: 3m
 Waterproof rating: IP68/IP69K
 Dperating temperature: -40° C-85° C
 certificate: ROHS.CE.
 Packing: 5Set/CTN(46.5x34x27.5cm)



Dimensions

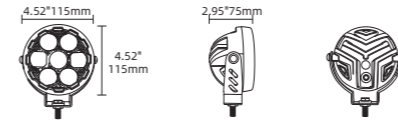

PART NO. KIT-M-N-7G

Parameter

Voltage	Power	LED Chios	Life
9-60VDC	9.3A [1pcs 5.8A]	3570*7	50000H

Material: Aluminum
 Color: White+Golden
 Beam pattern: Spot
 Cable: 3m
 Waterproof rating: IP68/IP69K
 Dperating temperature: -40° C-85° C
 certificate: ROHS.CE.
 Packing: 5Set/CTN(46.5x34x27.5cm)



PART NO. KIT-M-N-7 **Parameter**

Voltage	Power	LED Chios	Life
9-60VDC	9.3A [1pcs 4.6A]	3570*7	50000H

Material: Aluminum
 Color: White+Golden
 Beam pattern: Spot
 Cable: 3m
 Waterproof rating: IP68/IP69K
 Dperating temperature: -40° C-85° C
 certificate: ROHS.CE.
 Packing: 5Set/CTN(46.5x34x27.5cm)

Dimensions

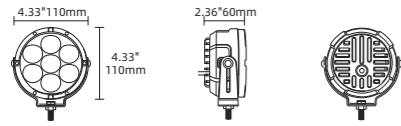

PART NO. KIT-M-20W+MC003 **Parameter**

Voltage	Power	LED Chios	Life	Lux
9-60VDC	5A [1pcs 2.44A]	3570*2	50000H	1lux@354m

Material: Aluminum
 Color: White+Golden
 Beam pattern: Spot
 Cable: 3m
 Waterproof rating: IP68/IP69K
 Dperating temperature: -40° C-85° C
 certificate: ROHS.CE.
 Packing: 0Set/CTN(00x00x00cm)

Dimensions

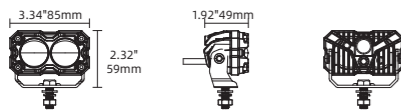

PART NO. KIT-M-40W+MC003 **Parameter**

Voltage	Power	LED Chios	Life	Lux
9-60VDC	6.3A [1pcs 3.34A]	3570*2	50000H	1lux@119m

Material: Aluminum
 Color: White+Golden
 Beam pattern: Spot
 Cable: 3m
 Waterproof rating: IP68/IP69K
 Dperating temperature: -40° C-85° C
 certificate: ROHS.CE.
 Packing: 0Set/CTN(00x00x00cm)

Dimensions

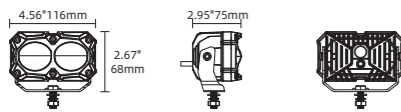

PART NO. KIT-M-F1+MC003 **Parameter**

Voltage	Power	LED Chios	Life	Lux
9-60VDC	3.5A [1pcs 1.83A]	3570*1	50000H	1lux@262m

Material: Aluminum
 Color: White+Golden
 Beam pattern: Spot
 Cable: 3m
 Waterproof rating: IP68/IP69K
 Dperating temperature: -40° C-85° C
 certificate: ROHS.CE.
 Packing: 0Set/CTN(00cm)

Dimensions

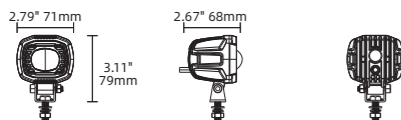

PART NO. KIT-M-Y2+MC003 **Parameter**

Voltage	Power	LED Chios	Life
9-60VDC	4.66A [1pcs 2.24A]	3570*2	50000H

Material: Aluminum
 Color: White+Amber
 Beam pattern: Spot
 Cable: 3m
 Waterproof rating: IP68/IP69K
 Dperating temperature: -40° C-85° C
 certificate: ROHS.CE.
 Packing: 0Set/CTN(00cm)

Dimensions

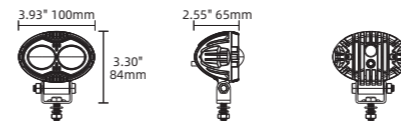

PART NO. KIT-M-F15-B **Parameter**

Voltage	Power	LED Chios	Life	Lux
9-60VDC	2.3A [1pcs 1.13A]	3570*1	50000H	1lux@354m

Material: Aluminum
 Color: White+Golden
 Beam pattern: Spot
 Cable: 3m
 Waterproof rating: IP68/IP69K
 Dperating temperature: -40° C-85° C
 certificate: ROHS.CE.
 Packing: 10Set/CTN(53.5x24x39cm)

Dimensions

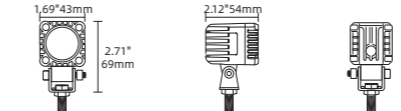

PART NO. KIT-M-F15-A+MC003 **Parameter**

Voltage	Power	LED Chios	Life	Lux
9-60VDC	2.8A [1pcs 1.44A]	3570*1	50000H	1lux@119m

Material: Aluminum
 Color: White+Golden
 Beam pattern: Spot
 Cable: 3m
 Waterproof rating: IP68/IP69K
 Dperating temperature: -40° C-85° C
 certificate: ROHS.CE.
 Packing: 10Set/CTN(53.5x24x39cm)

Dimensions

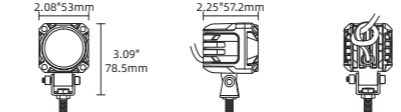

PART NO. KIT-M-N-M1-A+U **Parameter**

Voltage	Power	LED Chios	Life	Lux
9-60VDC	3.5A [1pcs 1.6A]	3570*1	50000H	1lux@262m

Material: Aluminum
 Color: White+Golden
 Beam pattern: Spot
 Cable: 3m
 Waterproof rating: IP68/IP69K
 Dperating temperature: -40° C-85° C
 certificate: ROHS.CE.
 Packing: 10Set/CTN(53.5x24x39cm)

Dimensions

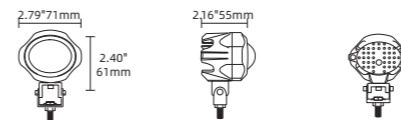



Dimensions

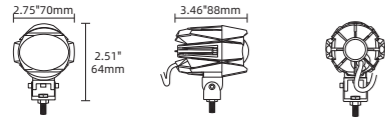

PART NO. KIT-M-N-S1-A+U **Parameter**

Voltage	Power	LED Chios	Life	Lux
9-60VDC	3.3A [1pcs 1.5A]	3570*1	50000H	1lux@226m

Material: Aluminum
 Color: White+Golden
 Beam pattern: Spot
 Cable: 3m
 Waterproof rating: IP68/IP69K
 Dperating temperature: -40° C-85° C
 certificate: ROHS.CE.
 Packing: 10Set/CTN(53.5×24×39cm)



Dimensions

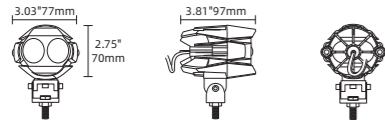

PART NO. KIT-M-N-S2-A+U **Parameter**

Voltage	Power	LED Chios	Life	Lux
9-60VDC	3.9A [1pcs 1.98A]	3570*2	50000H	1lux@287m

Material: Aluminum
 Color: White+Golden
 Beam pattern: Spot
 Cable: 3m
 Waterproof rating: IP68/IP69K
 Dperating temperature: -40° C-85° C
 certificate: ROHS.CE.
 Packing: 10Set/CTN(53.5×24×39cm)



Dimensions

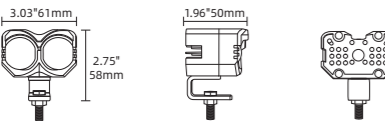

PART NO. KIT-M-N-M20 **Parameter**

Voltage	Power	LED Chios	Life	Lux
9-60VDC	3.1A [1pcs 1.4A]	3570*2	50000H	1lux@222m

Material: Aluminum
 Color: White+Golden
 Beam pattern: Spot
 Cable: 3m
 Waterproof rating: IP68/IP69K
 Dperating temperature: -40° C-85° C
 certificate: ROHS.CE.
 Packing: 10Set/CTN(53.5×24×39cm)



Dimensions

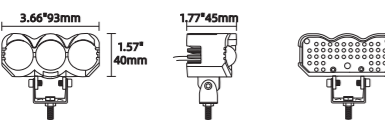

PART NO. KIT-M-N-M30 **Parameter**

Voltage	Power	LED Chios	Life	Lux
9-60VDC	3.9A [1pcs 1.7A]	3570*3	50000H	1lux@270m

Material: Aluminum
 Color: White+Golden
 Beam pattern: Spot
 Cable: 3m
 Waterproof rating: IP68/IP69K
 Dperating temperature: -40° C-85° C
 certificate: ROHS.CE.
 Packing: 10Set/CTN(53.5×24×39cm)



Dimensions

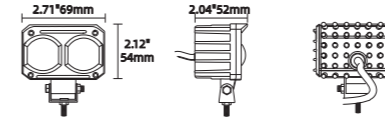

PART NO. KIT-M-N-Z2 **Parameter**

Voltage	Power	LED Chios	Life	Lux
9-60VDC	2.9A [1pcs 1.7A]	3570*2	50000H	1lux@283m

Material: Aluminum
 Color: White+Golden
 Beam pattern: Spot
 Cable: 3m
 Waterproof rating: IP68/IP69K
 Dperating temperature: -40° C-85° C
 certificate: ROHS.CE.
 Packing: 10Set/CTN(53.5×24×39cm)



Dimensions

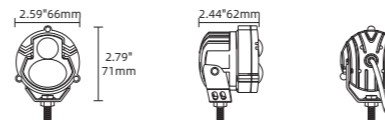

PART NO. KIT-M-N-24W **Parameter**

Voltage	Power	LED Chios	Life	Lux
9-60VDC	2.7A [1pcs 2.6A]	3570*2	50000H	1lux@331m

Material: Aluminum
 Color: White+Golden
 Beam pattern: Spot
 Cable: 3m
 Waterproof rating: IP68/IP69K
 Dperating temperature: -40° C-85° C
 certificate: ROHS.CE.
 Packing: 10Set/CTN(53.5×24×39cm)



Dimensions

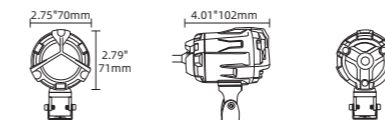

PART NO. KIT-M-N-MB **Parameter**

Voltage	Power	LED Chios	Life	Lux
9-60VDC	3.2A [1pcs 1.58A]	3570*1	50000H	1lux@350m

Material: Aluminum
 Color: White+Golden
 Beam pattern: Spot
 Cable: 3m
 Waterproof rating: IP68/IP69K
 Dperating temperature: -40° C-85° C
 certificate: ROHS.CE.
 Packing: 10Set/CTN(53.5×24×39cm)



Dimensions

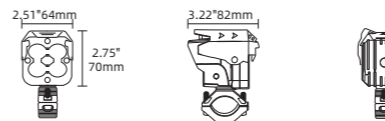

PART NO. KIT-M-N-4 **Parameter**

Voltage	Power	LED Chios	Life	Lux
9-60VDC	5.2A [1pcs 2.77A]	3570*4	50000H	1lux@413m

Material: Aluminum
 Color: White+Golden
 Beam pattern: Spot
 Cable: 3m
 Waterproof rating: IP68/IP69K
 Dperating temperature: -40° C-85° C
 certificate: ROHS.CE.
 Packing: 10Set/CTN(53.5×24×39cm)



Dimensions

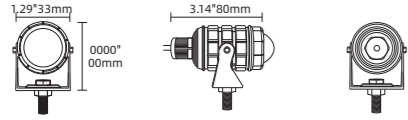

PART NO. KIT-M-M1

Parameter

Voltage	Power	LED Chios	Life	Lux
9-60VDC	2.5A [1pcs 1A]	3570*1	50000H	1lux@225m

Material: Aluminum
 Color: White+Golden
 Beam pattern: Spot
 Cable: 3m
 Waterproof rating: IP68/IP69K
 Dperating temperature: -40° C-85° C
 certificate: ROHS.CE.
 Packing: 3Set/CTN(63×32×49cm)



Dimensions

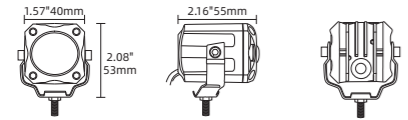

PART NO. KIT-M-Y1-A+MC-003

Parameter

Voltage	Power	LED Chios	Life
9-60VDC	3.3A [1pcs 1.5A]	3570*1	50000H

Material: Aluminum
 Color: White+Golden
 Beam pattern: Spot
 Cable: 3m
 Waterproof rating: IP68/IP69K
 Dperating temperature: -40° C-85° C
 certificate: ROHS.CE.
 Packing: 3Set/CTN(63×32×49cm)



Dimensions

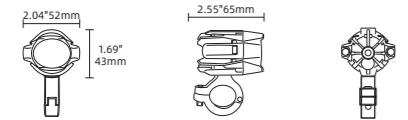

PART NO. KIT-M-MINI-N-S1-U

Parameter

Voltage	Power	LED Chios	Life
9-30VDC	2.7A [1pcs 1.28A]	3570*1	50000H

Material: Aluminum
 Color: White+Golden
 Beam pattern: Spot
 Cable: 3m
 Waterproof rating: IP68/IP69K
 Dperating temperature: -40° C-85° C
 certificate: ROHS.CE.
 Packing: 3Set/CTN(63×32×49cm)



Dimensions

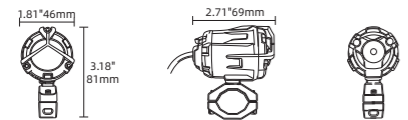

PART NO. KIT-MINI-M-N-MB

Parameter

Voltage	Power	LED Chios	Life	Lux
9-60VDC	2.8A [1pcs 1.26A]	3570*1	50000H	1lux@226m

Material: Aluminum
 Color: White+Golden
 Beam pattern: Spot
 Cable: 3m
 Waterproof rating: IP68/IP69K
 Dperating temperature: -40° C-85° C
 certificate: ROHS.CE.
 Packing: 3Set/CTN(63×32×49cm)

PART NO.

M-N-M3-T

M-T4-BS

M-T5-BS

M-T6-BS

M-T8-BS

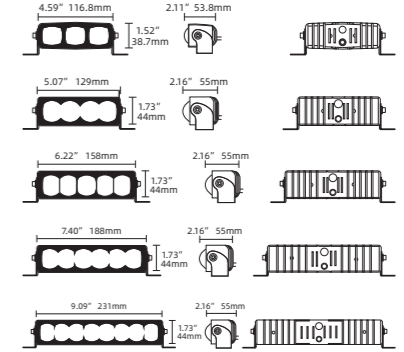

PART NO.	M-N-M3-T	M-T4-BS	M-T5-BS	M-T6-BS	M-T8-BS
Voltage	9-60V	9-60V	9-60V	9-60V	9-60V
Power	3.1A 40W	3.4A	3.4A	4.3A	6.5A
LED Chips	3570*3LED	3570*4LED	3570*5LED	3570*6LED	3570*8LED
Packing	50Set/CTN(46×28.5×36.5cm)	40Set/CTN(40×36.5×70cm)	40Set/CTN(40×36.5×70cm)	40Set/CTN(45.5×26.5×30cm)	50Set/CTN(45.5×26.5×30cm)

Material: Aluminum
 Color: White+Yellow
 Beam pattern: Spot(Strobe Mode,Constant Mode)
 Cable: 3m
 Waterproof rating: IP68/IP69K
 Dperating temperature: -40° C-85° C
 certificate: ROHS.CE.
 Life: 50000H

PART NO.

M-M1-BS

M-M2-BS

M-M3-BS

M-M4-BS

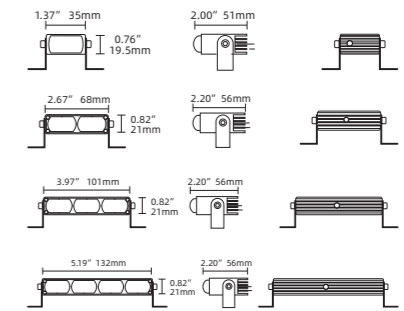

PART NO.	M-M1-BS	M-M2-BS	M-M3-BS	M-M4-BS
Voltage	9-60VDC	Color	Color	Color
Power	1.1A	2A	2.6A	3.1A
LED Chips	1LED	2LED	3LED	4LED
Packing	50Set/CTN(36.5×23×35cm)	50Set/CTN(36.5×23×35cm)	50Set/CTN(35×28.5×36.5cm)	50Set/CTN(35×28.5×36.5cm)

Material: Aluminum
 Color: White+Yellow
 Beam pattern: Spot(Strobe Mode,Constant Mode)
 Cable: 3m
 Waterproof rating: IP68/IP69K
 Dperating temperature: -40° C-85° C
 certificate: ROHS.CE.
 Life: 50000H

SAFETY CONTOUR LIGHTS



Dimensions

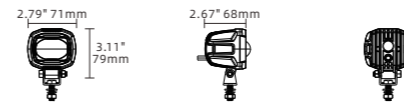

Dimensions



Dimensions

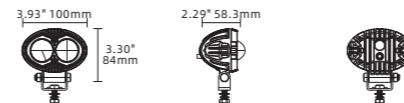

Dimensions

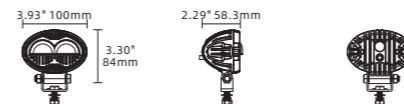

PART NO. BX3-F1-A

Parameter

Voltage	Power	LED Chios
9-80VDC	6.1W/12V@0.5A	5050*1pcs

Material: Aluminum
 Color: Red/Blue/Yellow
 Beam pattern: Spot
 Cable: 25cm
 Waterproof rating: IP68/IP69K
 Dperating temperature: -40° C-85° C
 certificate: ROHS.CE.ECE
 Packing: 50Set/CTN(46x25x42cm)



PART NO. BX3-F1-B

Parameter

Voltage	Power	LED Chios
9-80VDC	6W/12V@0.5A	5050*1pcs

Material: Aluminum
 Color: Red/Blue/Yellow
 Beam pattern: Spot
 Cable: 25cm
 Waterproof rating: IP68/IP69K
 Dperating temperature: -40° C-85° C
 certificate: ROHS.CE.ECE
 Packing: 50Set/CTN(46x25x42cm)



PART NO. BX4-T2

Parameter

Voltage	Power	LED Chios
9-80VDC	10W/12V@0.82A	5050*2pcs

Material: Aluminum
 Color: Red/Blue/Yellow
 Beam pattern: Spot
 Cable: 25cm
 Waterproof rating: IP68/IP69K
 Dperating temperature: -40° C-85° C
 certificate: ROHS.CE.ECE
 Packing: 50Set/CTN(46x25x42cm)



PART NO. BX4-T2-B

Parameter

Voltage	Power	LED Chios
9-80VDC	11.6W/12V@0.95A	5050*2pcs

Material: Aluminum
 Color: Red/Blue/Yellow
 Beam pattern: Spot
 Cable: 25cm
 Waterproof rating: IP68/IP69K
 Dperating temperature: -40° C-85° C
 certificate: ROHS.CE.ECE
 Packing: 50Set/CTN(46x25x42cm)

FORKLIFT LAMP LIGHTS



Dimensions

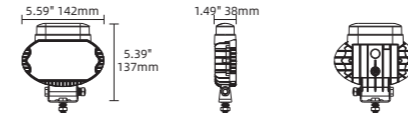

PART NO. 55C-FS-T5

Parameter

Voltage	Power	LED Chios	Lm	Lux
9-36VDC	18.7W/12V@1.55A	3030*32+22+10pcs	6400LM	1lux@//m

Material: Aluminum+ABS
 Color: White+Amber
 Beam pattern: Flood
 Cable: 26cm
 Waterproof rating: IP68/IP69K
 Dperating temperature: -40° C-85° C
 certificate: ROHS.CE.
 Packing: 20Set/CTN(35×31.5×30.5cm)

Dimensions

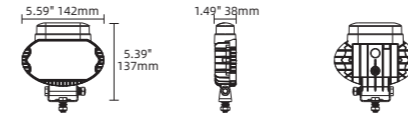

PART NO. 55C-FS-T1

Parameter

Voltage	Power	LED Chios	Lm	Lux
9-36VDC	18W/12V@1.5A	3030*32+32+10pcs	6400LM	1lux@//m

Material: Aluminum+ABS
 Color: White+Amber
 Beam pattern: Flood
 Cable: 26cm
 Waterproof rating: IP68/IP69K
 Dperating temperature: -40° C-85° C
 certificate: ROHS.CE.
 Packing: 20Set/CTN(35×31.5×30.5cm)

Dimensions

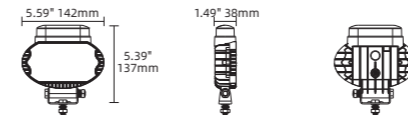

PART NO. 55C-FS-T2

Parameter

Voltage	Power	LED Chios	Lm	Lux
9-36VDC	17.2W/12V@1.43A	3030*25+22+10pcs	5700LM	1lux@//m

Material: Aluminum+ABS
 Color: White+Amber
 Beam pattern: Flood
 Cable: 26cm
 Waterproof rating: IP68/IP69K
 Dperating temperature: -40° C-85° C
 certificate: ROHS.CE.
 Packing: 20Set/CTN(35×31.5×30.5cm)

Dimensions

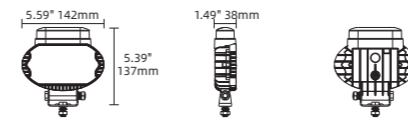

PART NO. 55C-FS-T3

Parameter

Voltage	Power	LED Chios	Lm	Lux
9-36VDC	18.7W/12V@1.56A	3030*32+22+10pcs	6400LM	1lux@//m

Material: Aluminum+ABS
 Color: White+Amber
 Beam pattern: Flood
 Cable: 26cm
 Waterproof rating: IP68/IP69K
 Dperating temperature: -40° C-85° C
 certificate: ROHS.CE.
 Packing: 20Set/CTN(35×31.5×30.5cm)

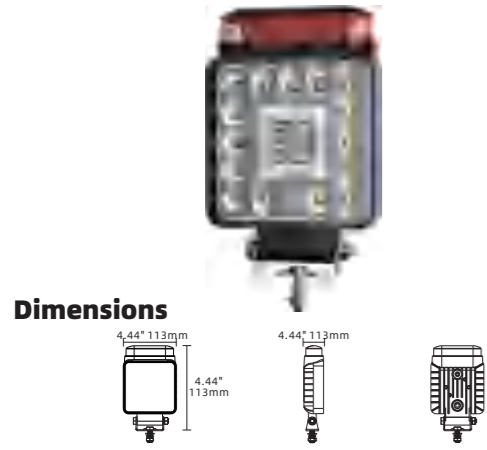

PART NO. H-37FS-31

Parameter

Voltage	Power	LED Chios	Lm	Lux
9-36VDC	17.8W/12V@1.48A	3030*31+10pcs	4100LM	1lux@//m

Material: Aluminum+ABS
 Color: White+Amber
 Beam pattern: Flood
 Cable: 22cm
 Waterproof rating: IP68/IP69K
 Dperating temperature: -40° C-85° C
 certificate: ROHS.CE.
 Packing: 20Set/CTN(35×27×32.5cm)

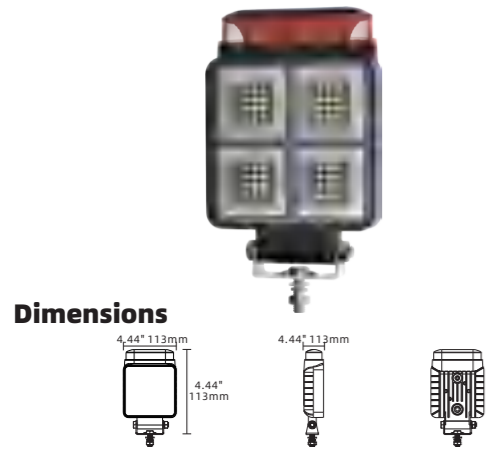

PART NO. H-37FS-64

Parameter

Voltage	Power	LED Chios	Lm	Lux
9-36VDC	18.5W/12V@1.54A	3030*80+10pcs	9000LM	1lux@//m

Material: Aluminum+ABS
 Color: White+Amber
 Beam pattern: Flood
 Cable: 22cm
 Waterproof rating: IP68/IP69K
 Dperating temperature: -40° C-85° C
 certificate: ROHS.CE.
 Packing: 20Set/CTN(35×27×32.5cm)

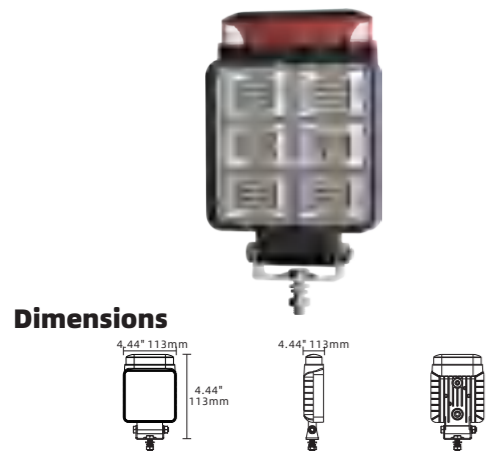

PART NO. H-37FS-72

Parameter

Voltage	Power	LED Chios	Lm	Lux
9-36VDC	19.5W/12V@1.62A	3030*72+10pcs	8200LM	1lux@//m

Material: Aluminum+ABS
 Color: White+Amber
 Beam pattern: Flood
 Cable: 22cm
 Waterproof rating: IP68/IP69K
 Dperating temperature: -40° C-85° C
 certificate: ROHS.CE.
 Packing: 20Set/CTN(35×27×32.5cm)

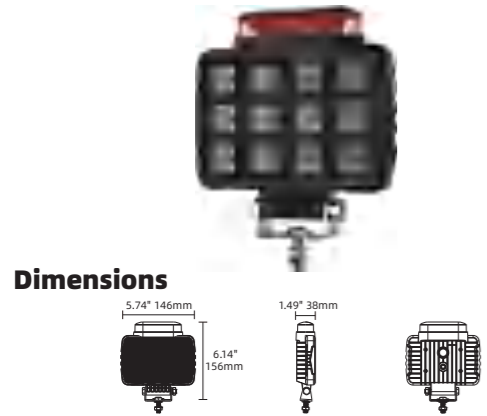

PART NO. 57C-FS-F48

Parameter

Voltage	Power	LED Chios	Lm	Lux
9-36VDC	19.5W/12V@1.62A	3030*72+10pcs	8200LM	1lux@//m

Material: Aluminum+ABS
 Color: White+Amber
 Beam pattern: Flood
 Cable: 25cm
 Waterproof rating: IP68/IP69K
 Dperating temperature: -40° C-85° C
 certificate: ROHS.CE.
 Packing: 20Set/CTN(35×31.5×30.5cm)

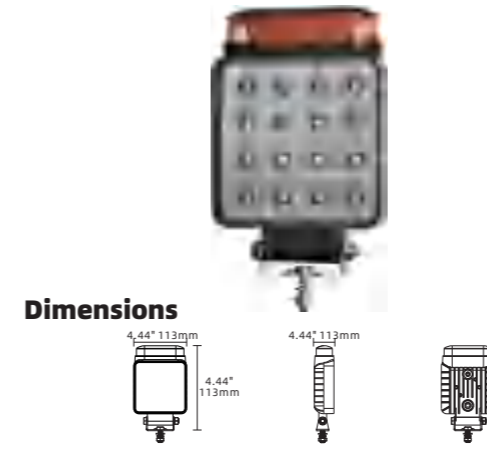

PART NO. H-37FS-16

Parameter

Voltage	Power	LED Chios	Lm	Lux
9-36VDC	17W/12V@1.43A	3030*16+10pcs	2600LM	1lux@//m

Material: Aluminum+ABS
 Color: White+Amber
 Beam pattern: Flood
 Cable: 22cm
 Waterproof rating: IP68/IP69K
 Dperating temperature: -40° C-85° C
 certificate: ROHS.CE.
 Packing: 20Set/CTN(35×27×32.5cm)

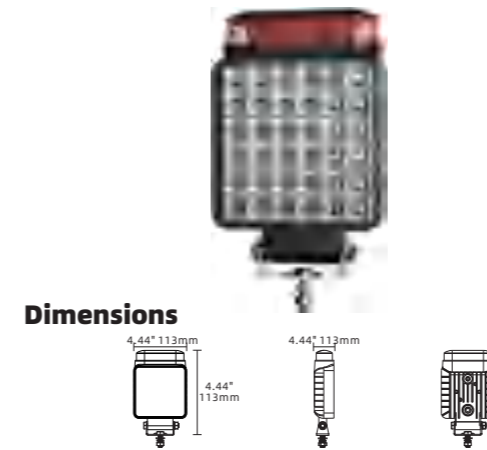

PART NO. H-37FS-36

Parameter

Voltage	Power	LED Chios	Lm	Lux
9-36VDC	15.8W/12V@1.3A	3030*36+10pcs	4600LM	1lux@//m

Material: Aluminum+ABS
 Color: White+Amber
 Beam pattern: Flood
 Cable: 22cm
 Waterproof rating: IP68/IP69K
 Dperating temperature: -40° C-85° C
 certificate: ROHS.CE.
 Packing: 20Set/CTN(35×27×32.5cm)

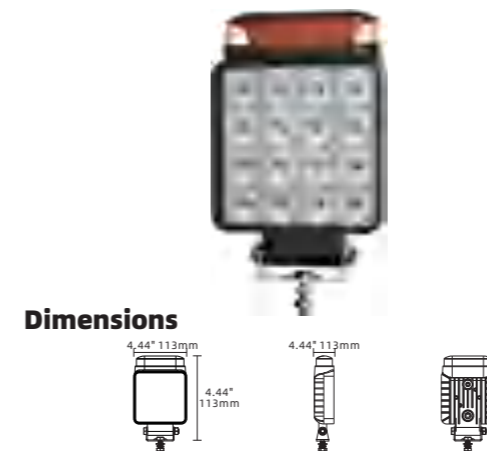

PART NO. H-37FS-16F

Parameter

Voltage	Power	LED Chios	Lm	Lux
9-36VDC	17W/12V@1.43A	3030*16+10pcs	2600LM	1lux@//m

Material: Aluminum+ABS
 Color: White+Amber
 Beam pattern: Flood
 Cable: 22cm
 Waterproof rating: IP68/IP69K
 Dperating temperature: -40° C-85° C
 certificate: ROHS.CE.
 Packing: 20Set/CTN(35×27×32.5cm)

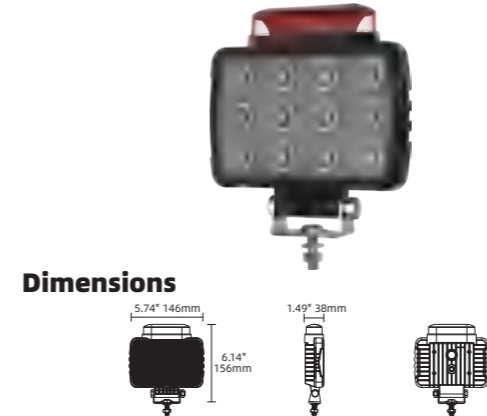

PART NO. 57C-FS-F48F

Parameter

Voltage	Power	LED Chios	Lm	Lux
9-36VDC	40W/12V@3.35A	3030*48+10pcs	5800LM	1lux@//m

Material: Aluminum+ABS
 Color: White+Amber
 Beam pattern: Flood
 Cable: 25cm
 Waterproof rating: IP68/IP69K
 Dperating temperature: -40° C-85° C
 certificate: ROHS.CE.
 Packing: 20Set/CTN(35×31.5×30.5cm)



LED WARNING LIGHT



PART NO. GD-COB-2/3/4/5/6/7/8

Dimensions	30mm	45mm	60mm	75mm	90mm	105mm	120mm

Parameter

Voltage	Power	Current	LED Chios	Mode	Operating Life
12-24V DC	8.5/9.5/10/13/26/28/38W	A±0.05	2/3/4//5/6/7/8pcs	Constant On + Strobe	50000H

Material: Aluminum
 Color: Yellow/White + Yellow (Yellow Strobe)
 Waterproof rating: IP68/IP69K
 Operating temperature: -40° C-85° C
 certificate: ROHS,CE.
 Packing: 30mm:20Set/CTN(50.5×26.5×27.5cm),45mm:20Set/CTN(65×26.5×27.5CM),60mm:20Set/CTN(79.5×26.5×27.5CM),
 75mm:20Set/CTN(94×26.5×27.5CM),90mm:20Set/CTN(108.5×26.5×27.5CM),
 105mm:20Set/CTN(123×26.5×27.5CM),120mm:20Set/CTN(137×26.5×27.5CM)



PART NO. GD-COB-CT-2/3/4/5/6/7/8

Dimensions	30mm	45mm	60mm	75mm	90mm	105mm	120mm

Parameter

Voltage	Power	Current	LED Chios	Mode	Operating Life
12-24V DC	8/10/11/14/22/30/35W	A±0.05	2/3/4//5/6/7/8pcs	Constant On + Strobe	50000H

Material: Aluminum
 Color: Yellow/White + Yellow (Yellow Strobe)
 Waterproof rating: IP68/IP69K
 Operating temperature: -40° C-85° C
 certificate: ROHS,CE.
 Packing: 30mm:10Set/CTN(50.5×26.5×27.5cm),45mm:10Set/CTN(65×26.5×27.5CM),60mm:10Set/CTN(79.5×26.5×27.5CM),
 75mm:10Set/CTN(94×26.5×27.5CM),90mm:10Set/CTN(108.5×26.5×27.5CM),
 105mm:10Set/CTN(123×26.5×27.5CM),120mm:10Set/CTN(137×26.5×27.5CM)



PART NO. GD-3030-4LED-2/4/6/8/10

Dimensions

23mm	
46mm	
69mm	
92mm	
120mm	

Parameter

Voltage	Power	Current	LED Chios	Mode	Operating Life
12-24V DC	3/6/9/12/16W	A±0.05	8/16/24/32/40pcs	Constant On + Strobe	50000H

Material: Aluminum
 Color: Yellow/White + Yellow (Yellow Strobe)
 Waterproof rating: IP68/IP69K
 Dperating temperature: -40° C-85° C
 certificate: ROHS.CE.
 Packing: 23mm:20Set/CTN(50.5×26.5×27.5CM),46mm:20Set/CTN(65×26.5×27.5CM),69mm:20Set/CTN(79.5×26.5×27.5CM),92mm:20Set/CTN(108.5×26.5×27.5CM)



PART NO. GD-3030-6LED-2/4/6/8

Dimensions

32mm	
60mm	
90mm	
120mm	

Parameter

Voltage	Power	Current	LED Chios	Mode	Operating Life
12-24V DC	3/6/9/13W	A±0.05	12/24/36/48pcs	Constant On + Strobe	50000H

Material: Aluminum
 Color: Yellow/White + Yellow (Yellow Strobe)
 Waterproof rating: IP68/IP69K
 Dperating temperature: -40° C-85° C
 certificate: ROHS.CE.
 Packing: 32mm:20Set/CTN(50.5×26.5×27.5cm),60mm:20Set/CTN(79.5×26.5×27.5cm),90mm:20Set/CTN(108×26.5×27.5cm),120mm:20Set/CTN(137.5×26.5×27.5cm)



PART NO. GD-3030-15LED-2/4/6/8/10

Dimensions

23mm	
46mm	
69mm	
92mm	
120mm	

Parameter

Voltage	Power	Current	LED Chios	Mode	Operating Life
12-24V DC	3/6/9/12/16W	A±0.05	30/45/60/120/150pcs	Constant On + Strobe	50000H

Material: Aluminum
 Color: Yellow/White + Yellow (Yellow Strobe)
 Waterproof rating: IP68/IP69K
 Dperating temperature: -40° C-85° C
 certificate: ROHS.CE.
 Packing: 23mm:20Set/CTN(50.5×26.5×27.5CM),46mm:20Set/CTN(65×26.5×27.5CM),69mm:20Set/CTN(79.5×26.5×27.5CM),92mm:20Set/CTN(108.5×26.5×27.5CM)

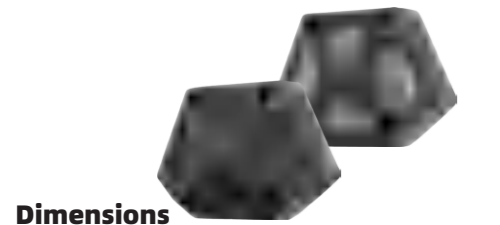
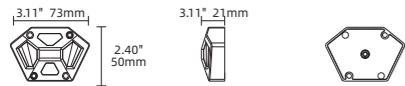
**Dimensions****PART NO. MD-14****Parameter**

Voltage	Power	Current	LED Chios	Operating Life:
12-24VDC	2.8W 0.23A	A±0.05	3030*14	50000H

Material: Aluminum
 Color: White + Yellow (Yellow Strobe)
 Mode: Constant On + Strobe
 Waterproof rating: IP65
 Dperating temperature: -40° C-85° C
 certificate: ROHS.CE.
 Packing: 100Set/CTN(39×22.5×42CM)
 Applicable: Cars / Motorcycles / Off-road Vehicles / Trucks / Forklifts / Beach Vehicles / Construction Vehicles / Ships

PART NO. MD-19**Parameter**

Voltage	Power	Current	LED Chios	Operating Life:
12-24VDC	2.8W 0.23A	A±0.05	3030*19	50000H

Material: Aluminum
 Color: White + Yellow (Yellow Strobe)
 Mode: Constant On + Strobe
 Waterproof rating: IP65
 Dperating temperature: -40° C-85° C
 certificate: ROHS.CE.
 Packing: 100Set/CTN(39×22.5×42CM)
 Applicable: Cars / Motorcycles / Off-road Vehicles / Trucks / Forklifts / Beach Vehicles / Construction Vehicles / Ships

PART NO. MD-26**Parameter**

Voltage	Power	Current	LED Chios	Operating Life:
12-24VDC	2.8W 0.23A	A±0.05	3030*26	50000H

Material: Aluminum
 Color: White + Yellow (Yellow Strobe)
 Mode: Constant On + Strobe
 Waterproof rating: IP65
 Dperating temperature: -40° C-85° C
 certificate: ROHS.CE.
 Packing: 100Set/CTN(39×22.5×42CM)
 Applicable: Cars / Motorcycles / Off-road Vehicles / Trucks / Forklifts / Beach Vehicles / Construction Vehicles / Ships

PART NO. MD-28**Parameter**

Voltage	Power	Current	LED Chios	Operating Life:
12-24VDC	2.8W 0.23A	A±0.05	3030*28	50000H

Material: Aluminum
 Color: White + Yellow (Yellow Strobe)
 Mode: Constant On + Strobe
 Waterproof rating: IP65
 Dperating temperature: -40° C-85° C
 certificate: ROHS.CE.
 Packing: 100Set/CTN(39×22.5×42CM)
 Applicable: Cars / Motorcycles / Off-road Vehicles / Trucks / Forklifts / Beach Vehicles / Construction Vehicles / Ships

PART NO. MD-30**Parameter**

Voltage	Power	Current	LED Chios	Operating Life:
12-24VDC	2.8W 0.23A	A±0.05	3030*30	50000H

Material: Aluminum
 Color: White (White Strobe)
 Mode: Constant On + Strobe
 Waterproof rating: IP65
 Dperating temperature: -40° C-85° C
 certificate: ROHS.CE.
 Packing: 100Set/CTN(39×22.5×42CM)
 Applicable: Cars / Motorcycles / Off-road Vehicles / Trucks / Forklifts / Beach Vehicles / Construction Vehicles / Ships

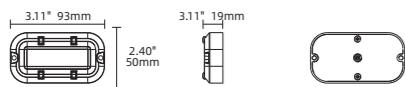
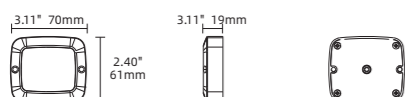
Dimensions**Dimensions****PART NO. MD-18****Parameter**

Voltage	Power	Current	LED Chios	Life
12-24VDC	0.26A	A±0.05	3030*18	50000H

Material: Aluminum
 Color: White/Yellow/Red/Blue/White-Red/White-Blue/White-Yellow/Red-Blue
 Mode: Constant On + Strobe (16 Modes Total)
 Waterproof rating: IP65
 Dperating temperature: -40° C-85° C
 certificate: ROHS.CE.
 Packing: 200Set/CTN(53×27×38cm)
 Applicable: Cars / Motorcycles / Off-road Vehicles / Trucks / Forklifts / Beach Vehicles / Construction Vehicles / Ships

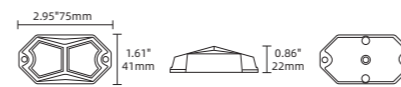
Dimensions**PART NO. I-BS-H-12LED****Parameter**

Voltage	Power	Current	LED Chios	Life
12-24VDC	36W	0.45A±0.05	3030*12	50000H

Material: Aluminum
 Color: White/Yellow/Red/Blue/White-Red/White-Blue/White-Yellow/Red-Blue
 Mode: Constant On + Strobe (16 Modes Total)
 Waterproof rating: IP65
 Dperating temperature: -40° C-85° C
 certificate: ROHS.CE.
 Packing: 200Set/CTN(53×27×38cm)
 Applicable: Cars / Motorcycles / Off-road Vehicles / Trucks / Forklifts / Beach Vehicles / Construction Vehicles / Ships

Dimensions**PART NO. I-BS-12LED****Parameter**

Voltage	Power	Current	LED Chios	Life
12-24VDC	36W	0.45A±0.05	3030*12	50000H

Material: Aluminum
 Color: White/Yellow/Red/Blue/White-Red/White-Blue/White-Yellow/Red-Blue
 Mode: Constant On + Strobe (16 Modes Total)
 Waterproof rating: IP65
 Dperating temperature: -40° C-85° C
 certificate: ROHS.CE.
 Packing: 200Set/CTN(53×27×38cm)
 Applicable: Cars / Motorcycles / Off-road Vehicles / Trucks / Forklifts / Beach Vehicles / Construction Vehicles / Ships

Dimensions**PART NO. I-BS-24LED****Parameter**

Voltage	Power	Current	LED Chios	Life
12-24VDC	18W	0.45A±0.05	3030*24	50000H

Material: Aluminum
 Color: White/Yellow/Red/Blue/White-Red/White-Blue/White-Yellow/Red-Blue
 Mode: Constant On + Strobe (16 Modes Total)
 Waterproof rating: IP65
 Dperating temperature: -40° C-85° C
 certificate: ROHS.CE.
 Packing: 200Set/CTN(53×27×38cm)
 Applicable: Cars / Motorcycles / Off-road Vehicles / Trucks / Forklifts / Beach Vehicles / Construction Vehicles / Ships

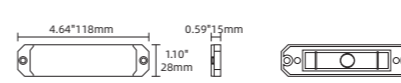
Dimensions**PART NO. I-BS-36LED-W+Y+W****Parameter**

Voltage	Power	Current	LED Chios	Operating Life:
12-24VDC	36W	0.45A±0.05	3030*36	50000H

Material: Aluminum
 Color: Yellow/White + Red-Blue
 Mode: Constant On + Strobe (16 Modes Total)
 Waterproof rating: IP65
 Dperating temperature: -40° C-85° C
 certificate: ROHS.CE.
 Packing: 200Set/CTN(53×27×38cm)
 Applicable: Cars / Motorcycles / Off-road Vehicles / Trucks / Forklifts / Beach Vehicles / Construction Vehicles / Ships

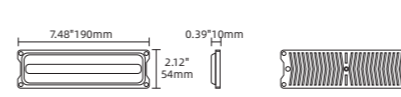
Dimensions



Dimensions



PART NO. I-BS-36LED-B-Y

Parameter

Voltage	Power	Current	LED Chios	Life
12-24VDC	36W	0.65A±0.05	3030*36	50000H

Material: Aluminum
 Color: Yellow/White + Red-Blue
 Mode: Constant On + Strobe (16 Modes Total)
 Waterproof rating: IP65
 Dperating temperature: -40° C-85° C
 certificate: ROHS.CE.
 Packing: 200Set/CTN(53×27×38cm)
 Applicable: Cars / Motorcycles / Off-road Vehicles / Trucks / Forklifts / Beach Vehicles / Construction Vehicles / Ships

PART NO. I-BS-4LED

Parameter

Voltage	Power	Current	LED Chios	Life
12-24VDC	12W	0.13A±0.05	3030*4	50000H

Material: Aluminum
 Color: White/Yellow/Red/Blue/White-Red/
 White-Blue/White-Yellow/Red-Blue
 Mode: Constant On + Strobe (16 Modes Total)
 Waterproof rating: IP65
 Dperating temperature: -40° C-85° C
 certificate: ROHS.CE.
 Packing: 200Set/CTN(53×27×38cm)
 Applicable: Cars / Motorcycles / Off-road Vehicles / Trucks / Forklifts / Beach Vehicles / Construction Vehicles / Ships

Dimensions

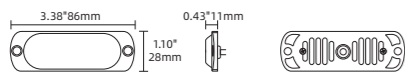

PART NO. I-BS-6LED

Parameter

Voltage	Power	Current	LED Chios	Life
12-24VDC	18W	0.25A±0.05	3030*18	50000H

Material: Aluminum
 Color: White/Yellow/Red/Blue/White-Red/
 White-Blue/White-Yellow/Red-Blue
 Mode: Constant On + Strobe (16 Modes Total)
 Waterproof rating: IP65
 Dperating temperature: -40° C-85° C
 certificate: ROHS.CE.
 Packing: 200Set/CTN(53×27×38cm)
 Applicable: Cars / Motorcycles / Off-road Vehicles / Trucks / Forklifts / Beach Vehicles / Construction Vehicles / Ships

Dimensions

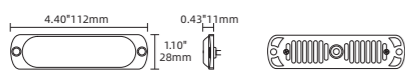

PART NO. I-BS-8LED

Parameter

Voltage	Power	Current	LED Chios	Life
12-24VDC	24W	0.25A±0.05	3030*24	50000H

Material: Aluminum
 Color: White/Yellow/Red/Blue/White-Red/
 White-Blue/White-Yellow/Red-Blue
 Mode: Constant On + Strobe (16 Modes Total)
 Waterproof rating: IP65
 Dperating temperature: -40° C-85° C
 certificate: ROHS.CE.
 Packing: 200Set/CTN(53×27×38cm)
 Applicable: Cars / Motorcycles / Off-road Vehicles / Trucks / Forklifts / Beach Vehicles / Construction Vehicles / Ships

Dimensions

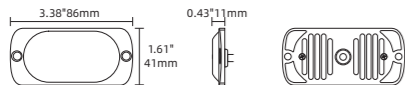

PART NO. I-BS-12LED

Parameter

Voltage	Power	Current	LED Chios	Life
12-24VDC	36W	0.3A±0.05	3030*12	50000H

Material: Aluminum
 Color: White/Yellow/Red/Blue/White-Red/
 White-Blue/White-Yellow/Red-Blue
 Mode: Constant On + Strobe (16 Modes Total)
 Waterproof rating: IP65
 Dperating temperature: -40° C-85° C
 certificate: ROHS.CE.
 Packing: 200Set/CTN(53×27×38cm)
 Applicable: Cars / Motorcycles / Off-road Vehicles / Trucks / Forklifts / Beach Vehicles / Construction Vehicles / Ships

Dimensions

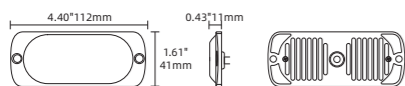

Dimensions



PART NO. I-BS-C-12LED

Parameter

Voltage	Power	Current	LED Chios	Life
12-24VDC	36W	0.28A±0.05	3030*12	50000H

Material: Aluminum
 Color: White/Yellow/White-Red-Blue/
 Red-White-Red/Red-Blue-Red/Yellow-Red-Blue
 Mode: Constant On + Strobe (16 Modes Total)
 Waterproof rating: IP65
 Dperating temperature: -40° C-85° C
 certificate: ROHS.CE.
 Packing: 200Set/CTN(53×27×38cm)
 Applicable: Cars / Motorcycles / Off-road Vehicles / Trucks / Forklifts / Beach Vehicles / Construction Vehicles / Ships

PART NO. I-BS-6-12

Parameter

Voltage	Power	Current	LED Chios	Life
12-24VDC	36W	0.2A±0.05	3030*12	50000H

Material: Aluminum
 Color: White/Yellow/Red/Blue/White-Red/
 White-Blue/White-Yellow/Red-Blue
 Mode: Constant On + Strobe (16 Modes Total)
 Waterproof rating: IP65
 Dperating temperature: -40° C-85° C
 certificate: ROHS.CE.
 Packing: 200Set/CTN(53×27×38cm)
 Applicable: Cars / Motorcycles / Off-road Vehicles / Trucks / Forklifts / Beach Vehicles / Construction Vehicles / Ships



Dimensions

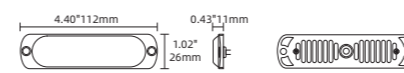

PART NO. I-BS-20LED

Parameter

Voltage	Power	Current	LED Chios	Life
12-24VDC	60W	0.26A±0.05	3030*20	50000H

Material: Aluminum
 Color: White/Yellow/Red/Blue/White-Red/
 White-Blue/White-Yellow/Red-Blue
 Mode: Constant On + Strobe (16 Modes Total)
 Waterproof rating: IP65
 Dperating temperature: -40° C-85° C
 certificate: ROHS.CE.
 Packing: 200Set/CTN(53×27×38cm)
 Applicable: Cars / Motorcycles / Off-road Vehicles / Trucks / Forklifts / Beach Vehicles / Construction Vehicles / Ships



Dimensions

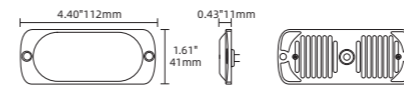

PART NO. I-BS-F-16LED

Parameter

Voltage	Power	Current	LED Chios	Life
12-24VDC	48W	0.5A±0.05	3030*16	50000H

Material: Aluminum
 Color: White/Yellow/Red/Blue
 Mode: Constant On + Strobe (16 Modes Total)
 Waterproof rating: IP65
 Dperating temperature: -40° C-85° C
 certificate: ROHS.CE.
 Packing: 200Set/CTN(53×27×38cm)
 Applicable: Cars / Motorcycles / Off-road Vehicles / Trucks / Forklifts / Beach Vehicles / Construction Vehicles / Ships



Dimensions

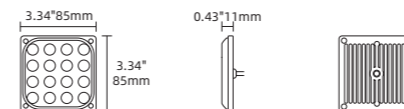

PART NO. I-BS-Y-14LED

Parameter

Voltage	Power	Current	LED Chios	Life
12-24VDC	42W	0.5A±0.05	3030*14	50000H

Material: Aluminum
 Color: White/Yellow/Red/Blue
 Mode: Constant On + Strobe (16 Modes Total)
 Waterproof rating: IP65
 Dperating temperature: -40° C-85° C
 certificate: ROHS.CE.
 Packing: 200Set/CTN(53×27×38cm)
 Applicable: Cars / Motorcycles / Off-road Vehicles / Trucks / Forklifts / Beach Vehicles / Construction Vehicles / Ships



Dimensions

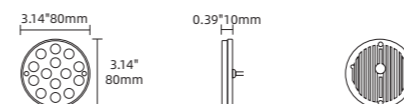

RGB DECORATION LIGHT



PART NO. N-Q2-35MM

Parameter

Voltage	LED Chips	Number of LEDs	Light type	Color
USB:12V Cigarette lighter:12v	5050	9LED*4	Atmosphere	RGB

Material: PVC+ABS
 Cable: 3m
 Waterproof rating: IP65
 Operating temperature: -40° C-85° C
 connector: ROHS,CE.
 certificate: USB/Cigarette lighter (optional)
 Packing: 1F:4Set/CTN(66.5*23*21cm),2F:4Set/CTN(92*23*21cm)
 3F:4Set/CTN(117.5*23*2cm)



PART NO. N-Q2-45MM

Parameter

Voltage	LED Chips	Number of LEDs	Light type	Color
USB:12V Cigarette lighter:12v	5050	9LED*4	Atmosphere	RGB

Material: PVC+ABS
 Cable: 3m
 Waterproof rating: IP65
 Operating temperature: -40° C-85° C
 connector: ROHS,CE.
 certificate: USB/Cigarette lighter (optional)
 Packing: 1F:4Set/CTN(66.5*23*21cm),2F:4Set/CTN(92*23*21cm)
 3F:4Set/CTN(117.5*23*2cm)



PART NO. N-Q1

Parameter

Voltage	LED Chips	Number of LEDs	Light type	Color
USB:12V Cigarette lighter:12v	5050*10	9LED*4	Atmosphere	RGB

Material: PVC+ABS
 Cable: 3m
 Waterproof rating: IP65
 Operating temperature: -40° C-85° C
 connector: ROHS,CE.
 certificate: USB/Cigarette lighter (optional)
 Packing: 2F:10Set/CTN(67.5*35*15CM),3F:10Set/CTN(97.5*35*15CM),4F:10Set/CTN(127.5*35*15CM),5F:10Set/CTN(156.5*35*15CM),6F:10Set/CTN(186.5*35*15CM)

PART NO. N-Q2

Parameter

Voltage	LED Chips	Number of LEDs	Light type	Color
USB:12V Cigarette lighter:12v	5050	9LED*4	Atmosphere	RGB

Material: PVC+ABS
 Cable: 3m
 Waterproof rating: IP65
 Operating temperature: -40° C-85° C
 connector: ROHS,CE.
 certificate: USB/Cigarette lighter (optional)
 Packing: 2F:10Set/CTN(67.5*35*15CM),3F:10Set/CTN(97.5*35*15CM),4F:10Set/CTN(127.5*35*15CM),5F:10Set/CTN(156.5*35*15CM),6F:10Set/CTN(186.5*35*15CM)



DIY SWITCH INSTALLATION

TWO LEAD WIRING HARNESS, MULTIPLE SWITCH STYLES ARE AVAILABLE



RELAY

Efficient protection power relay for safety protection.

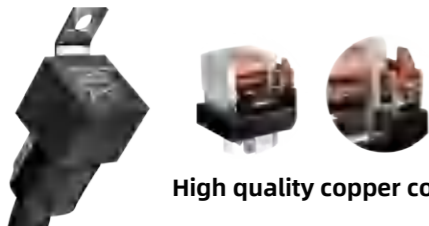

High quality copper coil

SAFE BOX

Comes with 10A/15A/20A fuse for overvoltage, overload and short circuit protection



Waterproof safety box

Three extra blade fuses for option

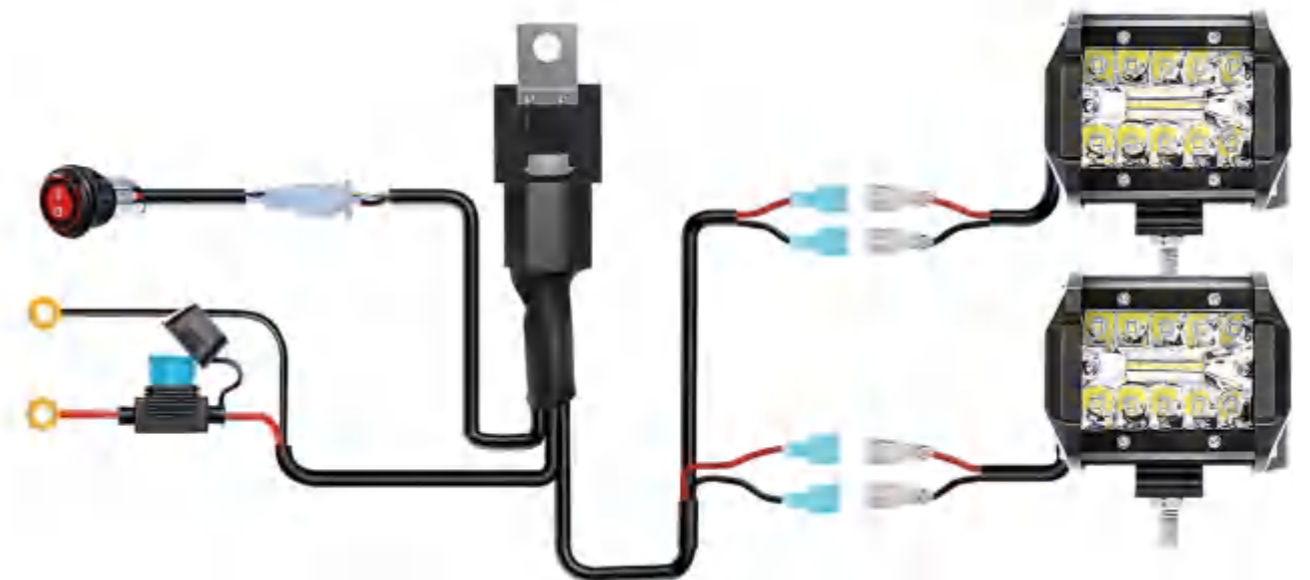

PART NO. XS-PT-2**Parameter**

Power	Current	Voltage	Specification	Wire Length
0-100W	0-30A	12V	1-to-1/1-to-2	3m

Material: PVC
 Wire gauge: 18 AWG
 Waterproof rating: IP65
 Operating temperature: -40° C-85° C
 Package Includes: 4 Sets of Blade Terminals / 3 Fuses
 certificate: ROHS.CE.
 Packing: 50Set/CTN(47x44x40cm)

**PART NO. XS-YX-2****Parameter**

Power	Current	Voltage	Specification	Wire Length
0-100W	0-30A	12V	1-to-1/1-to-2	3m

Material: PVC
 Wire gauge: 18 AWG
 Waterproof rating: IP65
 Operating temperature: -40° C-85° C
 Package Includes: 4 Sets of Blade Terminals / 3 Fuses
 certificate: ROHS.CE.
 Packing: 50Set/CTN(47x44x40cm)

**PART NO. XS-FOG-2****Parameter**

Power	Current	Voltage	Specification	Wire Length
0-100W	0-30A	12V	1-to-1/1-to-2	3m

Material: PVC
 Wire gauge: 18 AWG
 Waterproof rating: IP65
 Operating temperature: -40° C-85° C
 Package Includes: 4 Sets of Blade Terminals / 3 Fuses
 certificate: ROHS.CE.
 Packing: 50Set/CTN(47x44x40cm)

**PART NO. XS-SK-2****Parameter**

Power	Current	Voltage	Specification	Wire Length
0-100W	0-30A	12V	1-to-1/1-to-2	3m

Material: PVC
 Wire gauge: 18 AWG
 Waterproof rating: IP65
 Operating temperature: -40° C-85° C
 Package Includes: 4 Sets of Blade Terminals / 3 Fuses
 certificate: ROHS.CE.
 Packing: 50Set/CTN(47x44x40cm)

**PART NO. XS-BS-2****Parameter**

Power	Current	Voltage	Specification	Wire Length
0-100W	0-30A	12V	1-to-1/1-to-2	3m

Material: PVC
 Wire gauge: 18 AWG
 Waterproof rating: IP65
 Operating temperature: -40° C-85° C
 Package Includes: 4 Sets of Blade Terminals / 3 Fuses
 certificate: ROHS.CE.
 Packing: 50Set/CTN(47x44x40cm)

**PART NO. XS-M5-2****Parameter**

Power	Current	Voltage	Specification	Wire Length
0-100W	0-30A	12V	1-to-1/1-to-2	3m

Material: PVC
 Wire gauge: 18 AWG
 Waterproof rating: IP65
 Operating temperature: -40° C-85° C
 Package Includes: 4 Sets of Blade Terminals / 3 Fuses
 certificate: ROHS.CE.
 Packing: 50Set/CTN(47x44x40cm)

**PART NO. XS-BF-2****Parameter**

Power	Current	Voltage	Specification	Wire Length
0-80W	0-10A	12-24V	2-circuit 0.75 mm ²	3m

Material: PVC
 Wire gauge: 2x0.75²
 Waterproof rating: IP65
 Operating temperature: -40° C-85° C
 Package Includes: Wired controller
 certificate: ROHS.CE.
 Packing: 50Set/CTN(47x44x40cm)

**PART NO. XS-M-2****Parameter**

Power	Current	Voltage	Specification	Wire Length
0-40W	0-6A	12-60V	2-circuit 0.75 mm ²	3m

Material: PVC
 Wire gauge: 2x0.5²
 Waterproof rating: IP65
 Operating temperature: -40° C-85° C
 Package Includes: Wired controller
 certificate: ROHS.CE.
 Packing: 50Set/CTN(47x44x40cm)

**PART NO. MC-003****Parameter**

Material: Aluminum Alloy
 Specification: Fits 18-32MM Pipe Diameter
 Product Purpose: Spotlight/Work Light Bracket
 Product Weight: 110g
 Package Includes: 1 x Bracket / 2 x Washers / 2 x Screws / 1 x Wrench

**PART NO. MC-002****Parameter**

Material: Aluminum Alloy
 Specification: Fits 18-32MM Pipe Diameter
 Product Purpose: Spotlight/Work Light Bracket
 Product Weight: 110g
 Package Includes: 1 x Bracket / 2 x Washers / 2 x Screws / 1 x Wrench

**PART NO. MC-001****Parameter**

Material: Aluminum Alloy
 Specification: Fits 18-32MM Pipe Diameter
 Product Purpose: Spotlight/Work Light Bracket
 Product Weight: 110g
 Package Includes: 1 x Bracket / 2 x Washers / 2 x Screws / 1 x Wrench





PART NO. PD05-R-6

Packaging contents

1x Switch Panel
1x Switch Control Box
1x Voltage Protection Switch
1x Mounting Brackets Set
Parameters:60A



PART NO. PD05-RGB-6

Packaging contents

1x Switch Panel
1x Switch Control Box
1x Voltage Protection Switch
1x Mounting Brackets Set
Parameters:60A



PART NO. PD05-RGB-12

Packaging contents

1x Switch Panel
1x Switch Control Box
1x Voltage Protection Switch
1x Mounting Brackets Set
Parameters:80A



PART NO. PD05-APP-12

Packaging contents

1x Switch Panel
1x Switch Control Box
1x Voltage Protection Switch
1x Mounting Brackets Set
Parameters:80A



PART NO. PD05-APP-6

Packaging contents

1x Switch Panel
1x Switch Control Box
1x Voltage Protection Switch
1x Mounting Brackets Set
Parameters:60A



PART NO. PD05-Y-6

Packaging contents

1x Switch Panel
1x Switch Control Box
1x Voltage Protection Switch
1x Mounting Brackets Set
Parameters:60A



PART NO. PD05-Y-12

Packaging contents

1x Switch Panel
1x Switch Control Box
1x Voltage Protection Switch
1x Mounting Brackets Set
Parameters:80A



PART NO. PD05-Y-APP-12

Packaging contents

1x Switch Panel
1x Switch Control Box
1x Voltage Protection Switch
1x Mounting Brackets Set
Parameters:80A



PART NO. PD05-Y-APP-6

Packaging contents

1x Switch Panel
1x Switch Control Box
1x Voltage Protection Switch
1x Mounting Brackets Set
Parameters:60A



PART NO. PD05-R-8

Packaging contents

1x Switch Panel
1x Switch Control Box
1x Voltage Protection Switch
1x Mounting Brackets Set
Parameters:60A



PART NO. PD05-RGB-8

Packaging contents

1x Switch Panel
1x Switch Control Box
1x Voltage Protection Switch
1x Mounting Brackets Set
Parameters:60A



PART NO. PD05-APP-8

Packaging contents

1x Switch Panel
1x Switch Control Box
1x Voltage Protection Switch
1x Mounting Brackets Set
Parameters:60A



PART NO. PD05-Y-8

Packaging contents

1x Switch Panel
1x Switch Control Box
1x Voltage Protection Switch
1x Mounting Brackets Set
Parameters:60A



PART NO. PD05-Y-APP-8

Packaging contents

1x Switch Panel
1x Switch Control Box
1x Voltage Protection Switch
1x Mounting Brackets Set
Parameters:60A



GUANGDONG DXZ LIGHTING TECHNOLOGY CO., LTD.



[WECHAT]



[FACEBOOK]



[YOUTUBE]



[WEBSITE]

CONTACT US

Email: boss@dxzchina.com

Phone: 86-159 1571 7790 (Mon-Fri 9am-5pm (PST))

Facebook Page: www.facebook.com/DXZ.LED

Website: www.dxzchina.com

With reservation for misprints and possible changes.

CATALOGUE 2025